

JVC

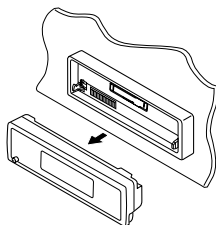

CASSETTE RECEIVER
CASSETTEN-RECEIVER
RADIOCASSETTE
RADIO/CASSETTESPELER

KS-LH60R

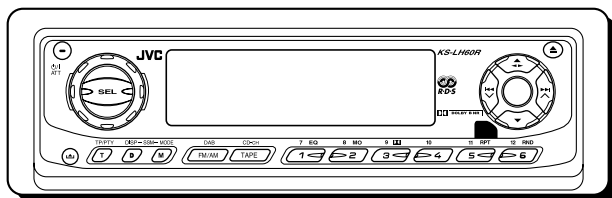

For installation and connections, refer to the separate manual.
Für den Einbau und die Anschlüsse siehe das eigenständige Handbuch.
Pour l'installation et les raccordements, se référer au manuel séparé.
Bijzonderheden over de installatie en aansluiting van het apparaat vindt u in de desbetreffende handleiding.

INSTRUCTIONS

BEDIENUNGSANLEITUNG
MANUEL D'INSTRUCTIONS
GEbruIKSAANWIJZING

GET0127-001A
[E/EX]

ENGLISH

DEUTSCH

FRANÇAIS

NETERLANDS

How to reset your unit

After detaching the control panel, press the reset button on the panel holder using a ball-point pen or a similar tool.

This will reset the built-in microcomputer.

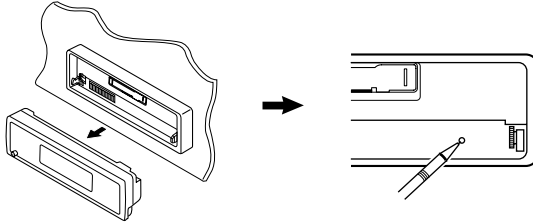

Note:

Your preset adjustments—such as preset channels or sound adjustments—will also be erased.

How to use the M (MODE) button

If you press M (MODE), the unit goes into functions mode (“MODE” flashes on the upper part of the display). While in functions mode, the number buttons work as different function buttons.

- When connecting a JVC MP3-compatible CD changer: The ▲/▼ buttons will also work as +10/–10 buttons after pressing M (MODE).

Ex.: When number button 2 works as MO (monaural) button.

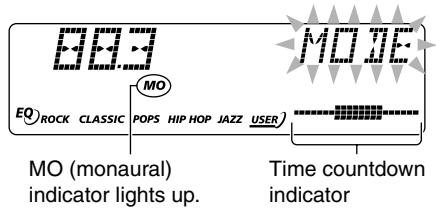
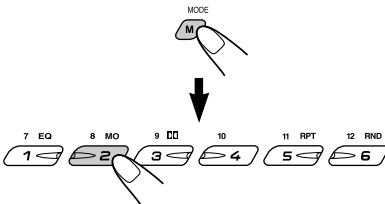

To use these buttons for original functions again after pressing M (MODE), wait for 5 seconds without pressing any of these buttons until the functions mode is cleared (“MODE” disappears from the display).

- Pressing M (MODE) again also clears the functions mode.

Thank you for purchasing a JVC product. Please read all instructions carefully before operation, to ensure your complete understanding and to obtain the best possible performance from the unit.

CONTENTS

How to reset your unit	2	OTHER MAIN FUNCTIONS	25
How to use the M (MODE) button	2	Changing the general settings (PSM)	25
LOCATION OF THE BUTTONS	4	Detaching the control panel	29
Control panel	4	CD CHANGER OPERATIONS	30
Remote controller	5	About MP3 discs	30
Preparing the remote controller	6	Playing discs	30
BASIC OPERATIONS	7	Selecting the playback modes	34
Turning on the power	7	EXTERNAL COMPONENT OPERATIONS ...	35
Setting the clock	8	Playing an external component	35
RADIO OPERATIONS	9	DAB TUNER OPERATIONS	36
Listening to the radio	9	Tuning in to an ensemble and one of the	
Storing stations in memory	10	services	36
Tuning in to a preset station	11	Storing DAB services in memory	37
RDS OPERATIONS	12	Tuning in to a preset DAB service	38
What you can do with RDS	12	What you can do more with DAB	39
Other convenient RDS functions and		TROUBLESHOOTING	40
adjustments	16	MAINTENANCE	42
TAPE OPERATIONS	19	SPECIFICATIONS	43
Listening to a cassette	19		
Finding the beginning of a tune	20		
Other convenient tape functions	21		
Prohibiting cassette ejection	22		
SOUND ADJUSTMENTS	23		
Selecting preset sound modes			
(C-EQ: custom equalizer)	23		
Adjusting the sound	24		

Note:

For security reasons, a numbered ID card is provided with this unit, and the same ID number is imprinted on the unit's chassis. Keep the card in a safe place, as it will help the authorities to identify your unit if stolen.

BEFORE USE

***For safety...**

- Do not raise the volume level too much, as this will block outside sounds, making driving dangerous.
- Stop the car before performing any complicated operations.

***Temperature inside the car...**

If you have parked the car for a long time in hot or cold weather, wait until the temperature in the car becomes normal before operating the unit.



LOCATION OF THE BUTTONS

Control panel

ENGLISH

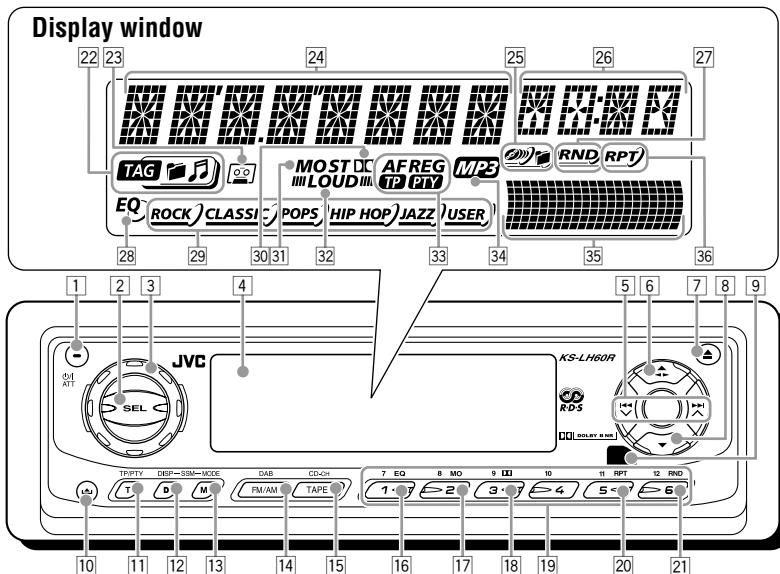

- 1 ϕ /I ATT (standby/on/attenuator) button
- 2 SEL (select) button
- 3 Control dial
- 4 Display window
- 5 \ll \gg buttons
- 6 \blacktriangle (up) button
- 7 \blacktriangleleft (tape direction) button
- 8 \blacktriangle (eject) button
- 9 \blacktriangledown (down) button
- 9 Remote sensor
- 10 \blacktriangle (control panel release) button
- 11 T (TP/PTY: traffic programme/programme type) button
- 12 D (DISP: display) button
 - Also functions as SSM buttons when pressed together with M (MODE) button.
- 13 M (MODE) button
 - Also functions as SSM buttons when pressed together with D (DISP) button.
- 14 FM/AM (DAB) button
- 15 TAPE (CD-CH: CD changer) button
- 16 EQ (equalizer) button
- 17 MO (monaural) button
- 18 \square (Dolby B) button
- 19 Number buttons
- 20 RPT (repeat) button
- 21 RND (random) button
 - Functions only when connecting to a CD changer.

Display window

- 22 Disc information indicators
 - TAG (ID3 Tag), \square (folder), \mathbb{M} (track/file)
 - Lights up only when playing an MP3 disc or a CD Text on a JVC MP3-compatible CD changer.
- 23 Tape-in indicator
- 24 Main display
- 25 Playback item indicators
 - \circ (disc)
 - Lights up only when connecting to a CD changer.
 - \square (folder)
 - Lights up only when playing an MP3 disc on a JVC MP3-compatible CD changer.
- 26 Source/clock display
- 27 RND (random) indicator
 - Lights up only when connecting to a CD changer.
- 28 EQ (equalizer) indicator
- 29 Sound mode (C-EQ: custom equalizer) indicators
 - ROCK, CLASSIC, POPS, HIP HOP, JAZZ, USER
- 30 \square (Dolby B) indicator
- 31 Tuner reception indicators
 - MO (monaural), ST (stereo)
- 32 LOUD (loudness) indicator
- 33 RDS indicator
 - AF, REG, TP, PTY
- 34 MP3 indicator
 - Lights up only when playing an MP3 disc on a JVC MP3-compatible CD changer.
- 35 Volume (or audio) level indicator
- 36 Equalizer pattern indicator
- 36 RPT (repeat) indicator



Remote controller

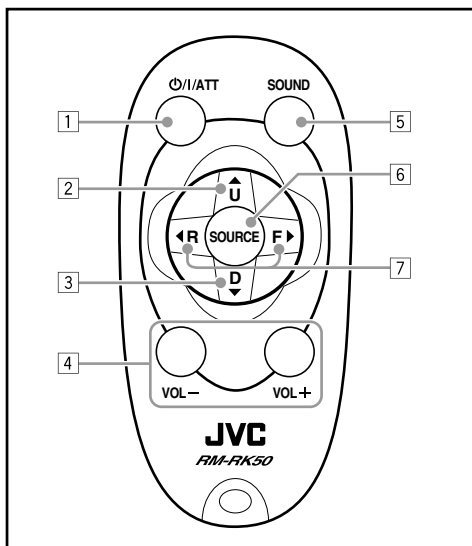

- 1 • Turns on the unit if pressed when the unit is turned off.
 - Turns off the unit if pressed and held until “SEE YOU” appears on the display.
 - Drops the volume level in a moment if pressed briefly.
Press again to resume the volume.
- 2 • Selects the band while listening to the radio (or the DAB tuner).
Each time you press the button, the band changes.
 - Changes the tape direction while listening to a cassette.
Each time you press the button, the tape direction changes alternately.
 - While playing an MP3 disc on an MP3-compatible CD changer;
 - Skips to the next disc if pressed briefly.
 - Skips to the next folder if pressed and held.

Note: While playing a CD on a CD changer, this always skips to the next disc.
- 3 • Selects the preset stations while listening to the radio (or the DAB tuner).
Each time you press the button, the preset station (or service) number increases, and the selected station (or service) is tuned in.
 - While playing an MP3 disc on an MP3-compatible CD changer;
 - Skips to the previous disc if pressed briefly.
 - Skips to the previous folder if pressed and held.

Note: While playing a CD on a CD changer, this always skips to the previous disc.
- 4 Functions the same as the control dial on the main unit.

Note: These buttons do not function for the preferred setting mode adjustment.
- 5 Selects the sound mode (C-EQ: custom equalizer).
Each time you press the button, the sound mode (C-EQ) changes.
- 6 Selects the source.
Each time you press the button, the source changes.
- 7 • Searches for stations while listening to the radio.
 - Selects services while listening to the DAB tuner if pressed briefly.
 - Searches for ensembles while listening to the DAB tuner if pressed for more than one second.
 - Functions as the fast-forward or rewind buttons if pressed and held while listening to a cassette.
To release this operation, press button 2 to resume playback.
 - Functions as Multi Music Scan buttons if pressed while listening to a cassette.
To release this operation, press button 2 to resume playback.
 - Fast-forwards or reverses the track/file if pressed and held while listening to the CD changer.
 - Skips to the beginning of the next track/file or goes back to the beginning of the current (or previous) tracks/files if pressed briefly while listening to the CD changer.

Preparing the remote controller

Before using the remote controller:

- Aim the remote controller directly at the remote sensor on the main unit. Make sure there is no obstacle in between.

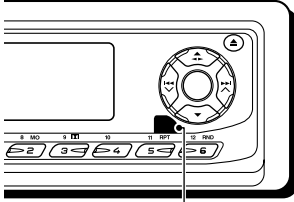

Remote sensor

- Do not expose the remote sensor to strong light (direct sunlight or artificial lighting).

Installing the battery

When the controllable range or effectiveness of the remote controller decreases, replace the battery.

1. Remove the battery holder.

- 1) Push out the battery holder in the direction indicated by the arrow using a ball-point pen or a similar tool.
- 2) Remove the battery holder.

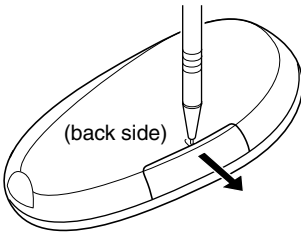

2. Place the battery.

Slide the battery into the holder with the + side facing upwards so that the battery is fixed in the holder.

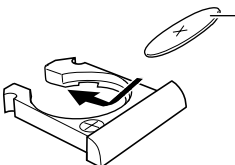

Lithium coin battery (product number: CR2025)

3. Return the battery holder.

Insert again the battery holder by pushing it until you hear a clicking sound.

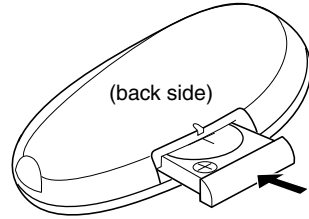

WARNING:

- Store the battery in a place where children cannot reach.
If a child accidentally swallows the battery, consult a doctor immediately.
- Do not recharge, short, disassemble, or heat the battery or dispose of it in a fire.
Doing any of these things may cause the battery to give off heat, crack, or start a fire.
- Do not leave the battery with other metallic materials.
Doing this may cause the battery to give off heat, crack, or start a fire.
- When throwing away or saving the battery, wrap it in tape and insulate; otherwise, the battery may start to give off heat, crack, or start a fire.
- Do not poke the battery with tweezers or similar tools.
Doing this may cause the battery to give off heat, crack, or start a fire.

CAUTION:

DO NOT leave the remote controller in a place (such as dashboards) exposed to direct sunlight for a long time. Otherwise, it may be damaged.

KS-LH60R is equipped with the steering wheel remote control function.

If your car is equipped with the steering wheel remote controller, you can operate this receiver using the controller.

- See the Installation/Connection Manual (separate volume) for connection to utilize this function.

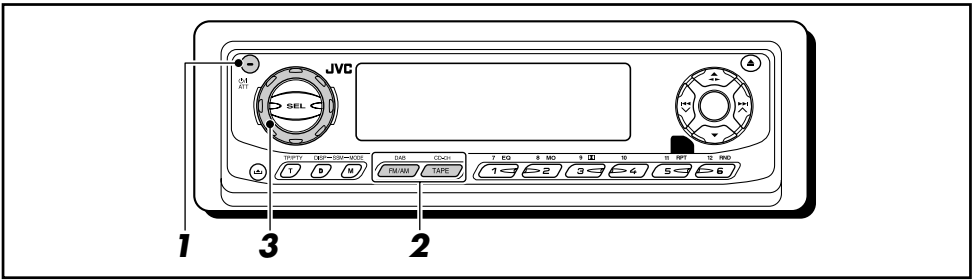

Turning on the power

1 Turn on the power.



Note on One-Touch Operation:

When you select a source in step 2 below, the power automatically comes on. You do not have to press this button to turn on the power.

2 Select the source.

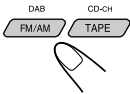

To operate the tuner (FM or AM), see pages 9 – 18.

To play a tape, see pages 19 – 22.

To operate the CD changer, see pages 30 – 34.

To operate the external component (LINE IN), see page 35.

To operate the DAB tuner, see pages 36 – 39.

3 Adjust the volume.

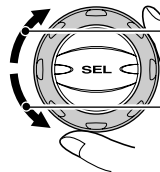

To increase the volume

To decrease the volume

Volume level appears.



Volume (or audio) level indicator (see page 27)

4 Adjust the sound as you want. (See pages 23 and 24.)

To drop the volume in a moment

Press **PWR/ATT** briefly while listening to any source. "ATT" starts flashing on the display, and the volume level will drop in a moment.

To resume the previous volume level, press the button briefly again.

- If you turn the control dial, you can also restore the sound.

To turn off the power

Press and hold **PWR/ATT** for more than one second.

"SEE YOU" appears, then the unit turns off.

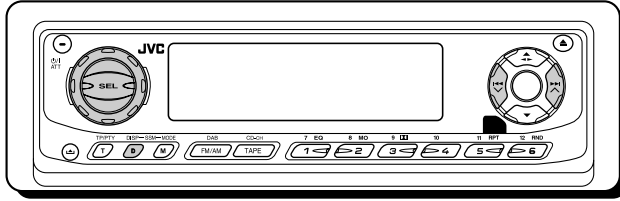

Setting the clock

You can also set the clock system to either 24 hours or 12 hours.

- 1 Press and hold SEL (select) for more than 2 seconds so that one of the PSM items appears on the display.** (PSM: see page 26.)



- 2 Set the hour.**

- 1 Select "CLOCK H" (hour) if not shown on the display.
- 2 Adjust the hour.

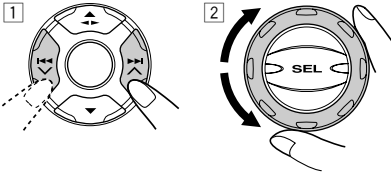

- 3 Set the minute.**

- 1 Select "CLOCK M" (minute).
- 2 Adjust the minute.

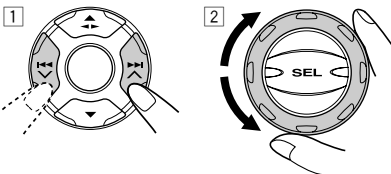

- 4 Set the clock system.**

- 1 Select "24H/12H."
- 2 Select "24H" or "12H."

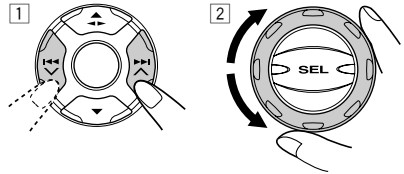

- 5 Finish the setting.**



Note:

To show the clock time on the display, see page 27.

To check other information during play, press D (DISP).



Each time you press the button, the other information will be shown on the upper part of the display. (See page 27 for details.)

- Pressing D (DISP) with the unit turned off will show the clock time for about 5 seconds.

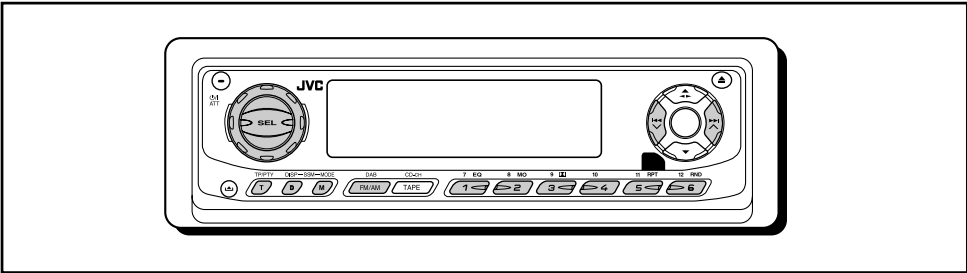

Listening to the radio

You can use either automatic searching or manual searching to tune in to a particular station.

Searching a station automatically: Auto search

1 Select the band (FM1 – 3, AM).

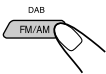

Each time you press the button, the band changes as follows:

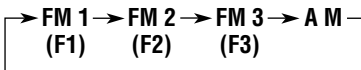

Selected band appears*.

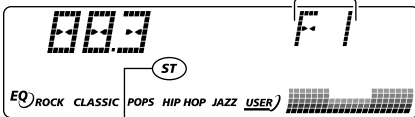

Lights up when receiving an FM stereo broadcast with sufficient signal strength.

* When "CLOCK" is set to "ON" (see page 27), the current indication will soon change to the clock time.

Note:

This receiver has three FM bands (FM1, FM2, FM3). You can use any one of them to listen to an FM broadcast.

2 Start searching a station.

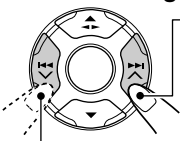

To search stations of higher frequencies

To search stations of lower frequencies

When a station is received, searching stops.

To stop searching before a station is received, press the same button you have pressed for searching.

Searching a station manually: Manual search

1 Select the band (FM1 – 3, AM).

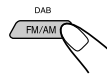

Each time you press the button, the band changes as follows:

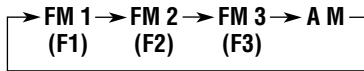

Note:

This receiver has three FM bands (FM1, FM2, FM3). You can use any one of them to listen to an FM broadcast.

2 Press and hold ►► ▲ or ◀◀ ▼ until "MANU" (manual) starts flashing on the display.

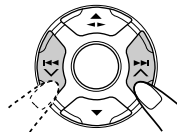



3 Tune in to a station you want while “MANU” (manual) is flashing.

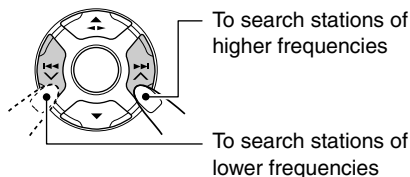

- If you release your finger from the button, the manual mode automatically turns off after 5 seconds.
- If you hold down the button, the frequency keeps changing (in 50 kHz intervals for FM and 9 kHz for AM—MW/LW) until you release the button.

When an FM stereo broadcast is hard to receive:



- 1 Press M (MODE) to enter the functions mode while listening to an FM stereo broadcast. “MODE” flashes on the upper part of the display.

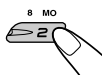

- 2 Press MO (monaural), while “MODE” is still flashing on the display, so that the MO indicator lights up on the display. Each time you press the button, the MO indicator lights up and goes off alternately.



MO (monaural) indicator

When the MO indicator is lit on the display, the sound you hear becomes monaural but the reception will be improved.

Storing stations in memory

You can use one of the following two methods to store broadcasting stations in memory.

- Automatic preset of FM stations: SSM (Strong-station Sequential Memory)
- Manual preset of both FM and AM stations

FM station automatic preset: SSM

You can preset 6 local FM stations in each FM band (FM1, FM2, and FM3).

1 Select the FM band (FM1 – 3) you want to store FM stations into.

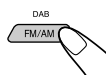

Each time you press the button, the band changes as follows:

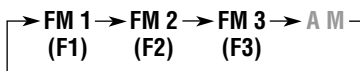

2 Press and hold both buttons for more than 2 seconds.



“- SSM -” appears, then disappears when automatic preset is over.

Local FM stations with the strongest signals are searched and stored automatically in the band number you have selected (FM1, FM2, or FM3). These stations are preset in the number buttons—No.1 (lowest frequency) to No.6 (highest frequency).

When automatic preset is over, the station stored in number button 1 will be automatically tuned in.

Manual preset

You can preset up to 6 stations in each band (FM1, FM2, FM3, and AM) manually.

Ex.: Storing FM station of 92.5 MHz into the preset number 1 of the FM1 band.

1 Select the band (FM1 – 3, AM) you want to store stations into (in this example, FM1).

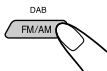

Each time you press the button, the band changes as follows:

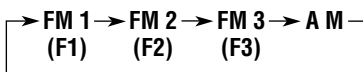

2 Tune in to a station (in this example, of 92.5 MHz).

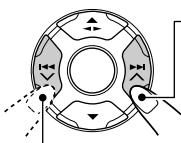

To search stations of higher frequencies

To search stations of lower frequencies

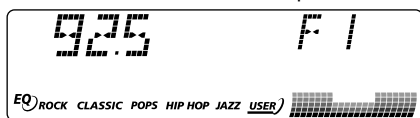

3 Press and hold the number button (in this example, 1) for more than 2 seconds.

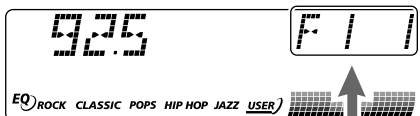

Selected band/preset number and “MEMO” (memory) appear alternately for a while.

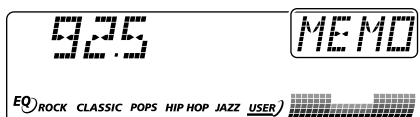

4 Repeat the above procedure to store other stations into other preset numbers.

Notes:

- A previously preset station is erased when a new station is stored in the same preset number.
- Preset stations are erased when the power supply to the memory circuit is interrupted (for example, during battery replacement). If this occurs, preset the stations again.

Tuning in to a preset station

You can easily tune in to a preset station. Remember that you must store stations first. If you have not stored them yet, see “Storing stations in memory” on pages 10 and 11.

1 Select the band (FM1 – 3, AM).

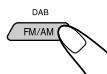

Each time you press the button, the band changes as follows:

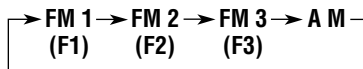

2 Select the number (1 – 6) for the preset station you want.

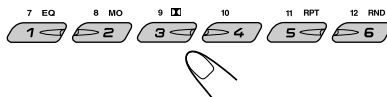



What you can do with RDS

RDS (Radio Data System) allows FM stations to send an additional signal along with their regular programme signals. For example, the stations send their station names, as well as information about what type of programme they broadcast, such as sports or music, etc.

Another advantage of RDS function is called "Enhanced Other Networks." By using the Enhanced Other Networks data sent from a station, you can tune in to a different station of a different network broadcasting your favorite programme or traffic announcement while listening to another programme or to another source such as tape.

By receiving the RDS data, this unit can do the following:

- Tracing the same programme automatically (Network-Tracking Reception)
- Standby Reception of TA (Traffic Announcement) or your favorite programme
- PTY (Programme Type) search
- Programme search
- And some other functions

Tracing the same programme automatically (Network-Tracking Reception)

When driving in an area where FM reception is not good, the tuner built in this unit automatically tunes in to another RDS station, broadcasting the same programme with stronger signals. So, you can continue to listen to the same programme in its finest reception, no matter where you drive. (See the illustration on page 18.)

Two types of the RDS data are used to make Network-Tracking Reception work correctly —PI (Programme Identification) and AF (Alternative Frequency).

Without receiving these data correctly from the RDS station you are listening to, Network-Tracking Reception will not operate.

To use Network-Tracking Reception

You can select the different modes of network-tracking reception to continue listening to the same programme in its finest reception. When shipped from the factory, "AF" is selected.

- **AF:** Network-Tracking Reception is activated with Regionalization set to "off." With this setting, the unit switches to another station within the same network when the receiving signals from the current station become weak. (In this mode, the programme may differ from the one currently received.) The AF indicator lights up but the REG indicator does not.
- **AF REG:** Network-Tracking Reception is activated with Regionalization set to "on." With this setting, the unit switches to another station, within the same network, broadcasting the same programme when the receiving signals from the current station become weak. Both the AF indicator and the REG indicator light up.
- **OFF:** Network-Tracking Reception is deactivated. Neither the AF indicator nor the REG indicator lights up.

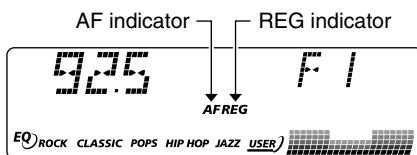

Note:

If a DAB tuner is connected and Alternative Reception (for DAB services) is activated, Network-Tracking Reception ("AF") is also activated automatically. On the other hand, Network-Tracking Reception cannot be deactivated without deactivating Alternative Reception. (See page 39.)



1 Press and hold SEL (select) for more than 2 seconds so that one of the PSM items appears on the display. (PSM: see page 26.)



2 Select “AF-REG” (alternative frequency/regionalization reception) if not shown on the display.

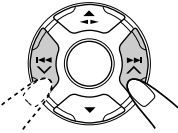

3 Select the desired mode—“AF,” “AF REG,” or “OFF.”

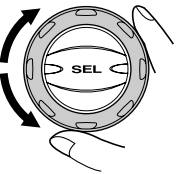

4 Finish the setting.



Using TA Standby Reception

TA Standby Reception allows the unit to switch temporarily to Traffic Announcement (TA) from the current source (another FM station, tape, or other connected components).

- TA Standby Reception will not work if you are listening to an AM station.

Press T (TP/PTY) to activate TA Standby Reception.



■ When the current source is FM, the TP indicator either lights up or flashes.

- If the TP indicator lights up, TA Standby Reception is activated.

If a station starts broadcasting a traffic announcement, “TRAFFIC” appears on the display, and this unit automatically tunes in to the station. The volume changes to the preset TA volume level (see page 17) and the traffic announcement can be heard.

- If the TP indicator flashes, TA Standby Reception is not yet activated since the station being received does not provide the signals used for TA Standby Reception. To activate TA Standby Reception, you need to tune in to another station providing these signals. Press ►►► ▲ or ◀◀◀ ▼ to search for such a station.

When a station providing these signals is tuned in, the TP indicator stops flashing and remains lit. Now TA Standby Reception is activated.

■ When the current source is other than FM, the TP indicator lights up.

If a station starts broadcasting a traffic announcement, “TRAFFIC” appears on the display, and this unit automatically changes the source and tunes in to the station.

To deactivate the TA Standby Reception, press T (TP/PTY) again. The TP indicator goes off.



Using PTY Standby Reception

PTY Standby Reception allows the unit to switch temporarily to your favorite programme (PTY: Programme Type) from the current source (another FM station, tape, or other connected components).

- *PTY Standby Reception will not work if you are listening to an AM station.*

You can select your favorite programme type for PTY Standby Reception.

When shipped from the factory, PTY Standby Reception is turned off. ("OFF" is selected for PTY Standby Reception.)

- 1 Press and hold SEL (select) for more than 2 seconds so that one of the PSM items appears on the display. (PSM: see page 26.)**



- 2 Select "PTY STBY" (standby) if not shown on the display.**



- 3 Select one of the twenty-nine PTY codes. (See page 18.)**

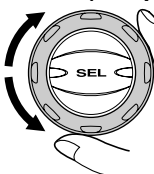

Selected code name appears on the display and is stored into memory.

- 4 Finish the setting.**



- **When the current source is FM, the PTY indicator either lights up or flashes.**

- **If the PTY indicator lights up,** PTY Standby Reception is activated.

If a station starts broadcasting the selected PTY programme, this unit automatically tunes in to the station.

- **If the PTY indicator flashes,** PTY Standby Reception is not yet activated since the station being received does not provide the signals used for PTY Standby Reception. To activate PTY Standby Reception, you need to tune in to another station providing these signals. Press ►► ▲ or ◀◀ ▼ to search for such a station.

When a station providing these signals is tuned in, the PTY indicator stops flashing and remains lit. Now PTY Standby Reception is activated.

- **When the current source is other than FM, the PTY indicator lights up.**

If a station starts broadcasting the selected PTY programme, this unit automatically changes the source and tunes in to the station.

To deactivate the PTY Standby Reception, select "OFF" in step 3 on the left column. The PTY indicator goes off.



Searching your favorite programme

You can search any one of the PTY codes. In addition, you can store your 6 favorite programme types in the number buttons. When shipped from the factory, the following 6 programme types have been stored in the number buttons (1 to 6).

To store your favorite programme types, see below.

To search your favorite programme type, see page 16.

1	2	3
POP M	ROCK M	EASY M
4	5	6
CLASSICS	AFFAIRS	VARIED

To store your favorite programme types

- 1 Press and hold T (TP/PTY) for more than 2 seconds while listening to an FM station.



The last selected PTY code appears.

- 2 Select one of the twenty-nine PTY codes. (See page 18.)



Selected code name appears on the display.

- 3 Press and hold the number button for more than 2 seconds to store the PTY code selected into the preset number you want.

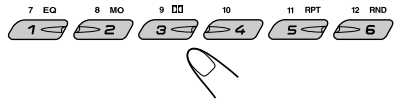

Selected preset number and "MEMO" (memory) appear alternately.

- 4 Press and hold T (TP/PTY) for more than 2 seconds to exit from this mode.





To search your favorite programme type

- 1 Press and hold T (TP/PTY) for more than 2 seconds while listening to an FM station.



The last selected PTY code appears.

- 2 To select one of your favorite programme type



or

To select any one of the twenty-nine PTY codes



Preset number appears only if you select a PTY code using the number buttons.



Ex.: When "ROCK M" is selected

- 3 Press **▶▶|** **^** or **|◀◀** **v** to start PTY search for your favorite programme.

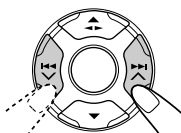

- If there is a station broadcasting a programme of the same PTY code as you selected, that station is tuned in.
- If there is no station broadcasting a programme of the same PTY code as you selected, the station will not change.

Note:

In some areas, the PTY search will not work correctly.

Other convenient RDS functions and adjustments

Automatic selection of the station when using the number buttons

Usually when you press the number button, the preset station is tuned in. However, when the preset station is an RDS station, something different will happen. If the signals from that preset station are not sufficient for good reception, this unit, using the AF data, tunes in to another frequency broadcasting the same programme as the original preset station is broadcasting. (Programme search)

- The unit takes some time to tune in to another station using programme search.

To activate programme search, follow the procedure below.

- See also "Changing the general settings (PSM)" on page 25.

- 1 Press and hold SEL (select) for more than 2 seconds so that one of the PSM items appears on the display.
- 2 Press **▶▶|** **^** or **|◀◀** **v** to select "P(Programme)-SEARCH."
- 3 Turn the control dial clockwise to select "ON." Now programme search is activated.
- 4 Press SEL (select) to finish the setting.

To cancel programme search, repeat the same procedure and select "OFF" in step 3 by turning the control dial counterclockwise.



Changing the display mode while listening to an FM station

You can change the initial indication on the display to station name (PS NAME) or station frequency (FREQ) while listening to an FM RDS station.

- See also “Changing the general settings (PSM)” on page 25.
- 1 Press and hold SEL (select) for more than 2 seconds so that one of the PSM items appears on the display.
 - 2 Press ►►| ▲ or |◄◄ ▼ to select “TU DISP” (tuner display).
 - 3 Turn the control dial to set to the desired indication (“PS NAME” or “FREQ”).
 - 4 Press SEL (select) to finish the setting.

Note:

By pressing D (DISP), you can change the display while listening to an FM RDS station. Each time you press the button, the following information appears on the main display:

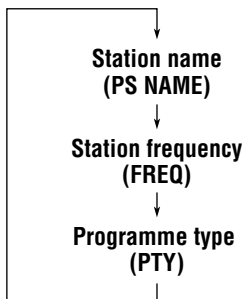

- Then, the display goes back to the original indication in several seconds.
- For more details, see “To set the clock display —CLOCK” on page 27.

Setting the TA volume level

You can preset the volume level for TA Standby Reception. When a traffic programme is received, the volume level automatically changes to the preset level.

- See also “Changing the general settings (PSM)” on page 25.
- 1 Press and hold SEL (select) for more than 2 seconds so that one of the PSM items appears on the display.
 - 2 Press ►►| ▲ or |◄◄ ▼ to select “TA VOL” (TA volume).
 - 3 Turn the control dial to set to the desired volume.
You can set it from “VOL 00” to “VOL 50.”
 - 4 Press SEL (select) to finish the setting.

Automatic clock adjustment

When shipped from the factory, the clock built in this unit is set to be readjusted automatically using the CT (Clock Time) data in the RDS signal.

If you do not want to use automatic clock adjustment, follow the procedure below.

- See also “Changing the general settings (PSM)” on page 25.
- 1 Press and hold SEL (select) for more than 2 seconds so that one of the PSM items appears on the display.
 - 2 Press ►►| ▲ or |◄◄ ▼ to select “AUTO ADJ” (adjustment).
 - 3 Turn the control dial counterclockwise to select “OFF.”
Now automatic clock adjustment is canceled.
 - 4 Press SEL (select) to finish the setting.

To reactivate clock adjustment, repeat the same procedure and select “ON” in step 3 by turning the control dial clockwise.

Note:

You must stay tuned to the same station for more than 2 minutes after setting “AUTO ADJ” to “ON.” Otherwise, the clock time will not be adjusted. (This is because the unit takes up to 2 minutes to capture the CT data in the RDS signal.)



PTY codes

NEWS:	News	SOCIAL:	Programmes on social activities
AFFAIRS:	Topical programmes expanding on current news or affairs	RELIGION:	Programmes dealing with any aspect of belief or faith, or the nature of existence or ethics
INFO:	Programmes which impart advice on a wide variety of topics	PHONE IN:	Programmes where people can express their views either by phone or in a public forum
SPORT:	Sport events	TRAVEL:	Programmes about travel destinations, package tours, and travel ideas and opportunities
EDUCATE:	Educational programmes	LEISURE:	Programmes concerned with recreational activities such as gardening, cooking, fishing, etc.
DRAMA:	Radio plays	JAZZ:	Jazz music
CULTURE:	Programmes on national or regional culture	COUNTRY:	Country music
SCIENCE:	Programmes on natural science and technology	NATION M:	Current popular music from another nation or region, in that country's language
VARIED:	Other programmes like comedies or ceremonies	OLDIES:	Classic pop music
POP M:	Pop music	FOLK M:	Folk music
ROCK M:	Rock music	DOCUMENT:	Programmes dealing with factual matters, presented in an investigative style
EASY M:	Easy-listening music		
LIGHT M:	Light music		
CLASSICS:	Classical music		
OTHER M:	Other music		
WEATHER:	Weather information		
FINANCE:	Reports on commerce, trading, the Stock Market, etc.		
CHILDREN:	Entertainment programmes for children		

The same programme can be received on different frequencies.

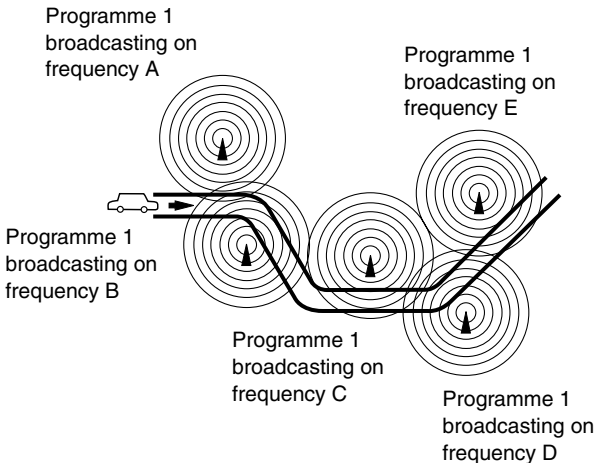

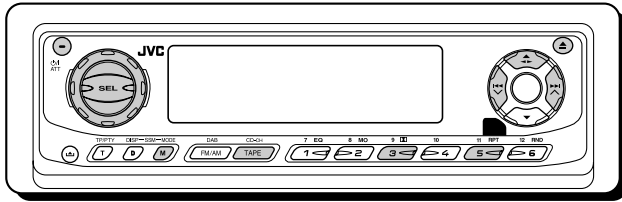

Listening to a cassette

You can play back type I (normal) tapes.

1 Open the control panel.

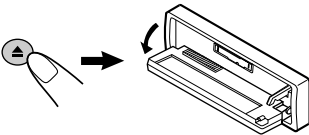

Note on One-Touch Operation:

When a cassette is already in the cassette compartment, pressing **TAPE (CD-CH)** turns on the unit and starts tape play automatically.

2 Insert a cassette into the cassette compartment.

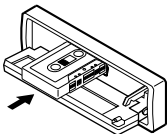

The unit turns on and tape play starts automatically.

3 Close the control panel by hand.

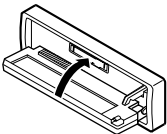

4 Select the tape direction.

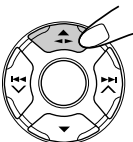

Each time you press **◀▶**, the tape direction changes alternately between forward (**TAPE >>>**) and reverse (**TAPE <<<**).

To stop play and eject the cassette

Press **▲**.

Tape play stops, the control panel flips down. The cassette automatically ejects from the cassette compartment. The source changes to the previously selected one.

If you change the source, tape play also stops (without ejecting the cassette this time).

- You can also eject the cassette by pressing **▲** while the unit is turned off.

To fast-forward and rewind a tape

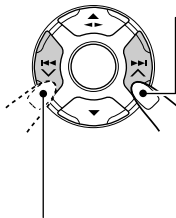

Press and hold **▶▶ ▲** for more than one second to fast-forward the tape.

When the tape reaches its end, the tape is reversed and playback starts from the beginning of the other side.

Press and hold **◀◀ ▼** for more than one second to rewind the tape.

When the tape reaches its end, playback of the same side starts.

To stop fast-forward and rewind at any position on the tape, press **◀▶**.



Tape play starts from that position on the tape.

Notes:

- When one side of the tape reaches its end during play, the other side of the tape automatically starts playing. (Auto Reverse)
- When the tape reaches its end while fast-forwarding, the tape direction will be changed automatically.



To play back tapes recorded with the Dolby B NR*

- 1 Press M (MODE) to enter the functions mode while listening to a tape. "MODE" flashes on the upper part of the display.
- 2 Press  (Dolby B), while "MODE" is still flashing on the display so that the  (Dolby B) indicator lights up. "DOLBY B" also appears on the display for several seconds.

To cancel the Dolby B NR, repeat steps 1 and 2 again so that the  (Dolby B) indicator goes off.

* Manufactured under license from Dolby Laboratories.
"Dolby" and the double-D symbol are trademarks of Dolby Laboratories.

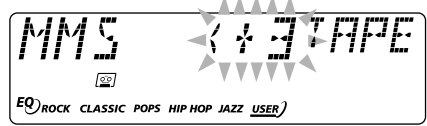

Ex.: When you locate three tunes ahead of the current tune

Each time you press the buttons, the number changes up to ±9.
When the beginning of the specified tune is located, playback starts automatically.

Notes:

- While locating a specified tune:
 - If the tape is rewound to its beginning, playback starts from the beginning of that side.
 - If the tape is fast-forwarded to the end, it is reversed and played from the beginning of the other side.
- In the following cases, the Multi Music Scan function may not operate correctly:
 - Tapes with tunes having long pianissimo passages (very quiet parts) or non-recorded portions between tunes.
 - Tapes with short non-recorded sections.
 - Tapes with high level of noise or humming between tunes.
 - Tapes with tunes recorded at low recording levels.
 - The Dolby NR setting does not match. For example, if Dolby B NR is on and the tape was recorded with no Dolby NR.



Finding the beginning of a tune

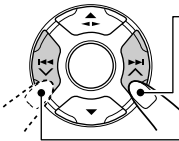

Multi Music Scan (MMS) allows you to automatically start playback from the beginning of a specified tune. You can specify up to 9 tunes ahead of or before the current tune.

During playback

Specify the tune you want to locate (how many tunes ahead of or before the current tune).



Press    to locate a tune ahead of the current tune on the cassette.

Press    to locate a tune before the current tune on the cassette.



Other convenient tape functions

Skipping the blank portions on the tape

You can skip blank portions between the tunes (Blank Skip).

When this function is turned on, the unit fast-forwards (skipping blank portions of 15 seconds or more), to the next tune and starts playback.

- See also “Changing the general settings (PSM)” on page 25.

- 1 Press and hold SEL (select) for more than 2 seconds so that one of the PSM items appears on the display. (PSM: see page 26.)**



- 2 Press >>>| ^ or <<<| v to select “B.SKIP” (blank skip).**



- 3 Turn the control dial clockwise to select “ON.”**

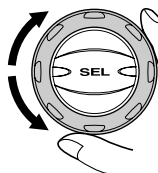

Now Blank Skip is activated.

- 4 Finish the setting.**



To cancel Blank Skip, repeat the same procedure and select “OFF” in step **3** by turning the control dial counterclockwise.

Playing the current tune repeatedly

You can play the current tune repeatedly (Repeat Play).



- 1 Press M (MODE) to enter the functions mode while playing a tune you want to hear over again on a cassette.
“MODE” flashes on the upper part of the display.



- 2 Press RPT (repeat), while “MODE” is still on the display, so that “REPEAT” appears on the display.

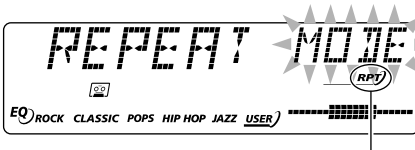

Lights up when Repeat Play is turned on.

When the tune has been played, the tape is automatically rewound to the beginning of that tune and the same tune will be played again.

To cancel Repeat Play, repeat steps 1 and 2 again so that the RPT indicator goes off.

Note:

In the following cases, Blank Skip and Repeat Play may not operate correctly:

- Tapes with tunes having long pianissimo passages (very quiet parts) or non-recorded portions during tunes.
- Tapes with short non-recorded sections.
- Tapes with high level noise or humming between tunes.
- Tapes with tunes recorded at low recording levels.
- The Dolby NR setting does not match. For example, if Dolby B NR is on and the tape was recorded with no Dolby NR.

Prohibiting cassette ejection

You can prohibit cassette ejection and lock a cassette in the cassette compartment.

While pressing TAPE (CD-CH), press and hold ϕ /I ATT for more than 2 seconds.

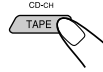

“NO EJECT” flashes on the display for about 5 seconds, and the cassette is locked and cannot be ejected.



To cancel the prohibition and unlock the cassette

While pressing TAPE (CD-CH), press and hold ϕ /I ATT again for more than 2 seconds. “EJECT OK” flashes on the display for about 5 seconds, and the cassette is unlocked.



Note:

If you press \blacktriangle while cassette ejection is prohibited, the control panel flips down, but the cassette continues to play and cannot be ejected.



Selecting preset sound modes (C-EQ: custom equalizer)

You can select a preset sound mode (C-EQ: custom equalizer) suitable to the music genre.

- There is a time limit in doing the following procedure. If the setting is canceled before you finish, start from step **1** again.

1 Press M (MODE) to enter the functions mode.



“MODE” flashes on the upper part of the display.

2 Press EQ (equalizer) while “MODE” is still flashing on the display.



The last selected sound mode is recalled and applied to the current source.



Sound mode indicator flashes.

Ex.: If you have selected “USER” previously

3 Select the sound mode you want.



Each time you press the button, the sound modes change as follows:



Sound mode indicator flashes.

Ex.: When you select “ROCK”

Indication	For:	Preset values		
		BAS	TRE	LOUD
USER	(Flat sound)	00	00	OFF
ROCK	Rock or disco music	+03	+01	ON
CLASSIC	Classical music	+01	-02	OFF
POPS	Light music	+04	+01	OFF
HIP HOP	Funk or rap music	+02	00	ON
JAZZ	Jazz music	+02	+03	OFF

Note:

You can adjust each sound mode to your preference. Once you make an adjustment, it is automatically stored for the currently selected sound mode. See “Adjusting the sound” on page 24.



Adjusting the sound

You can adjust the sound characteristics to your preference.

1 Select the item you want to adjust.



Each time you press the button, the adjustable items change as follows:

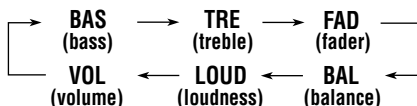

Indication	To do:	Range
BAS*1	Adjust the bass.	-06 (min.) +06 (max.)
TRE*1	Adjust the treble.	-06 (min.) +06 (max.)
FAD*2	Adjust the front and rear speaker balance.	R06 (Rear only) F06 (Front only)
BAL	Adjust the left and right speaker balance.	L06 (Left only) R06 (Right only)
LOUD*1	Boost low and high frequencies to produce a well-balanced sound at low volume level.	LOUD ON LOUD OFF
VOL*3	Adjust the volume.	00 (min.) 50 (max.)

*1 When you adjust the bass, treble, or loudness, the adjustment you have made is stored for the currently selected sound mode (C-EQ) including "USER."

*2 If you are using a two-speaker system, set the fader level to "00."

*3 Normally the control dial works as the volume control. So you do not have to select "VOL" to adjust the volume level.

2 Adjust the setting.

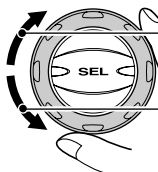

To increase the level or turn on the loudness

To decrease the level or turn off the loudness



Equalization pattern changes as you adjust the bass or treble.

Ex. 1: When you adjust "TRE" (treble)



Ex. 2: When you turn on the loudness

3 Repeat steps 1 and 2 to adjust the other items.

To reset each sound mode to the factory settings, repeat the same procedure and reassign the preset values listed in the table on page 23.



Changing the general settings (PSM)

You can change the items listed on the next page by using the PSM (Preferred Setting Mode) control.

Basic Procedure

- 1** Press and hold SEL (select) for more than 2 seconds so that one of the PSM items appears on the display. (See page 26.)



- 2** Select the PSM item you want to adjust.

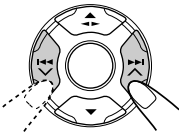

Ex.: When you select "LEVEL"

- 3** Adjust the PSM item selected.

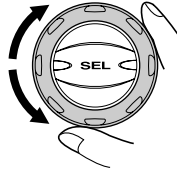

Ex.: When you select "AUDIO 2"

- 4** Repeat steps 2 and 3 to adjust the other PSM items if necessary.

- 5** Finish the setting.





Preferred Setting Mode (PSM) items

- For detailed operations of each PSM items, refer to the pages listed in the table.

Indications		Selectable values/items		Factory-preset settings	See page
CLOCK H	Hour adjustment	0 – 23 (1 – 12)		0 (0:00)	8
CLOCK M	Minute adjustment	00 – 59		00 (0:00)	8
24H/12H	24/12-hour time display	12H	24H	24H	8
AUTO ADJ	Automatic clock setting	OFF	ON	ON	17
CLOCK	Clock display	OFF	ON	ON	27
TU DISP	Tuner display	PS NAME ↔ FREQ		PS NAME	17
AF-REG	Alternative frequency/ Regionalization reception	AF ↙	↔ AF REG OFF*1 ↘	AF	12, 13
PTY STBY	PTY standby	OFF → 29 programme types (see page 18) ↑		OFF	14
TA VOL	Traffic announcement volume	VOL 00 – VOL 50		VOL 20	17
P-SEARCH	Programme search	OFF	ON	OFF	16
DAB AF*2	Alternative frequency search	AF OFF	AF ON	AF ON	39
DAB VOL*2	DAB volume adjustment	VOL –12	VOL 12	VOL 00	39
LEVEL	Level display	AUDIO 1 ↙	↔ AUDIO 2 OFF ↘	AUDIO 2	27
DIMMER	Dimmer mode	AUTO ↙	↔ OFF ON ↘	AUTO	27
TEL	Telephone muting	OFF ↙	↔ MUTING 1 MUTING 2 ↘	OFF	27
BEEP	Key-touch tone	OFF	ON	ON	28
SCROLL	Scroll mode	ONCE ↙	↔ AUTO OFF ↘	ONCE	28
B.SKIP	Blank skip	OFF	ON	OFF	21
EXT IN*3	External component	CHANGER	LINE IN	CHANGER	28
TAG DISP	Tag display	TAG OFF	TAG ON	TAG ON	28

*1 Displayed only when the “DAB AF” is set to “AF OFF.”

*2 Displayed only when the DAB tuner is connected.

*3 Displayed only when one of the following sources is selected—FM, AM, and TAPE.



To set the clock display—CLOCK

You can set the clock to be shown on the display when the unit is turned on.

When shipped from the factory, the clock is set to be shown on the display.

- ON: Clock display is turned on.
- OFF: Clock display is turned off. When “OFF” is selected, the other information (see table below) appears instead of the clock display (except when “LINE IN” is selected as the source).

When CLOCK is set to OFF:

Source	Initial indication	Pressing D (DISP)
Tuner (FM/AM/DAB)	Band	Clock appears for about 5 seconds.
TAPE or CD-CH	“TAPE” or disc number	

When CLOCK is set to ON:

Source	Initial indication	Pressing D (DISP)
Tuner (FM/AM/DAB)	Clock	Band appears for about 5 seconds.
TAPE	Clock	“TAPE” appears for about 5 seconds.
CD-CH	Clock	Disc number and track/file number appear alternately each time you press the button.

To select the level meter—LEVEL

You can select the level meter display according to your preference.

When shipped from the factory, “AUDIO 2” is selected.

- AUDIO 1: Shows the audio level indicator.
- AUDIO 2: Alternates “AUDIO 1” setting and illumination display.
- OFF: Erases the audio level indicator.

To select the dimmer mode—DIMMER

When you turn on the car headlights, the display automatically dims (Auto Dimmer).

When shipped from the factory, Auto Dimmer mode is activated.

- AUTO: Activates Auto Dimmer.
- OFF: Cancels Auto Dimmer.
- ON: Always dims the display.

Note:

Auto Dimmer equipped with this unit may not work correctly on some vehicles, particularly on those having a control dial for dimming.

In this case, set the dimmer mode to “ON” or “OFF.”

To select the telephone muting—TEL

This mode is used when a cellular phone system is connected. Depending on the phone system used, select either “MUTING 1” or “MUTING 2,” whichever mutes the sounds from this unit. When shipped from the factory, this mode is deactivated.

- MUTING 1: Selects this if this setting can mute the sounds while using the cellular phone.
- MUTING 2: Selects this if this setting can mute the sounds while using the cellular phone.
- OFF: Cancels the telephone muting.



To turn on/off the key-touch tone—BEEP

You can deactivate the key-touch tone if you do not want it to beep each time you press a button. When shipped from the factory, the key-touch tone is activated.

- ON: Activates the key-touch tone.
- OFF: Deactivates the key-touch tone.

To select the scroll mode—SCROLL

You can select the scroll mode for the disc information (when the entire text cannot be shown at once).

When shipped from the factory, scroll mode is set to “ONCE.”

- ONCE: Scrolls only once.
- AUTO: Repeats the scroll (5-second intervals in between).
- OFF: Cancels scroll mode.

Note:

Even if the scroll mode is set to “OFF,” you can scroll the display by pressing D (DISP) for more than one second.

To select the external component to use—EXT IN

You can connect the external component to the CD changer jack on the rear using the Line Input Adapter KS-U57 (not supplied).

To use the external component as the playback source through this unit, you need to select which component—CD changer or external component—to use.

When shipped from the factory, CD changer is selected as the external component.

- CHANGER: To use the CD changer.
- LINE IN: To use the external component other than CD changer.

Note:

For connecting the Line Input Adapter KS-U57 and the external component, refer to the Installation/Connection Manual (separate volume).

To turn the tag display on or off—TAG DISP

This function takes effect only when JVC MP3-compatible CD changer is connected.

An MP3 file can contain file information called “ID3 Tag” where its album name, performer, track title, etc. are recorded.

There are two versions—ID3v1 (ID3 Tag version 1) and ID3v2 (ID3 Tag version 2). Only ID3v1 can be shown.

When shipped from the factory, “TAG ON” is selected.

- TAG ON: Turns on the ID3 tag display while playing MP3 files.
 - If an MP3 file does not have ID3 tags, folder name and file name appear.

Note:

If you change the setting from “TAG OFF” to “TAG ON” while playing an MP3 file, the tag display will be activated when the next file starts playing.

- TAG OFF: Turns off the ID3 tag display while playing MP3 files. (Only the folder name and file name can be shown.)



Detaching the control panel

You can detach the control panel when leaving the car.

When detaching or attaching the control panel, be careful not to damage the connectors on the back of the control panel and on the panel holder.

Detaching the control panel

Before detaching the control panel, be sure to turn off the power.

1 Unlock the control panel.

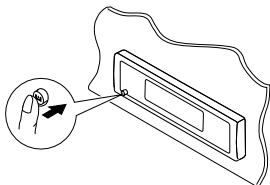

2 Pull the control panel out of the unit.

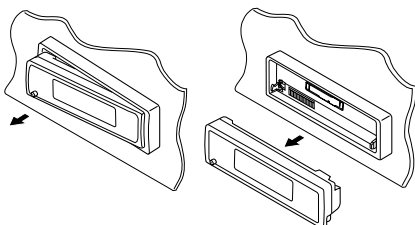

3 Put the detached control panel into the provided case.

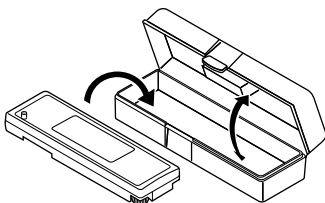

Attaching the control panel

1 Insert the right side of the control panel into the groove on the panel holder.

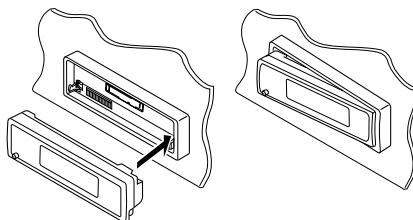

2 Press the left side of the control panel to fix it to the panel holder.

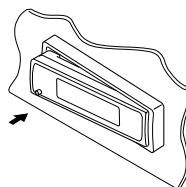

Note on cleaning the connectors:

If you frequently detach the control panel, the connectors will deteriorate.

To minimize this possibility, periodically wipe the connectors with a cotton swab or cloth moistened with alcohol, being careful not to damage the connectors.

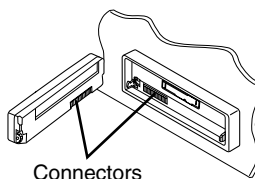



CD CHANGER OPERATIONS

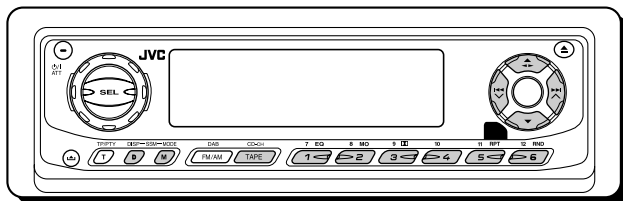

We recommend that you use the JVC MP3-compatible CD changer with your unit.

By using this CD changer, you can play back your original CD-Rs (Recordable) and CD-RWs (Rewritable) recorded either in audio CD format or in MP3 format.

- You can also connect other CH-X series CD changers (except CH-X99 and CH-X100). However, they are not compatible with MP3 discs, so you cannot play back MP3 discs.
- You cannot use the KD-MK series CD changers with this unit.

Before operating your CD changer:

- Refer also to the Instructions supplied with your CD changer.
- If no discs are in the magazine of the CD changer or the discs are inserted upside down, "NO DISC" will appear on the display. If this happens, remove the magazine and set the discs correctly.
- If no magazine is loaded in the CD changer, "NO MAG" appears on the display. If this happens, insert the magazine in the CD changer.
- If "RESET 1" – "RESET 8" appears on the display, something is wrong with the connection between this unit and the CD changer. If this happens, check the connection and make sure the cords are connected firmly. Then, press the reset button of the CD changer.

About MP3 discs

MP3 "files (tracks)" can be recorded in "folders"—in PC terminology.

During recording, the files and folders can be arranged in a way similar to arranging files and folders of computer data.

"Root" is similar to the root of a tree. Every file and folder can be linked to and be accessed from the root.

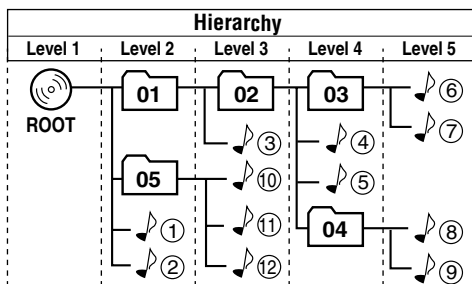

01 : Folders and their playback order

① : MP3 files and their playback order

Playing discs

Select the CD changer (CD).



*1 If you have changed the "EXT IN" setting to "LINE IN" (see page 28), you cannot select the CD changer.

When the current disc is an MP3 disc:

Playback starts from the first folder of the current disc once file check is completed.

Selected disc number*2

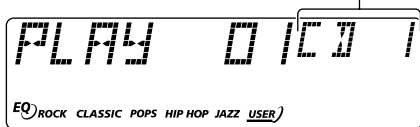

Folder or album name*3

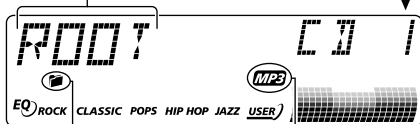

■ (folder) indicator MP3 indicator

*2 When "CLOCK" is set to "ON" (see page 27), the current indication will soon change to the clock time.

*3 If some MP3 files are recorded without being included in a folder, they are played back first and "ROOT" appears as the folder name.

When the current disc is a CD:

Playback starts from the first track of the current disc.

Selected disc number*4



Current track

Elapsed playing time number

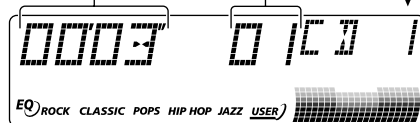

*4 When "CLOCK" is set to "ON" (see page 27), the current indication will soon change to the clock time.

Notes:

- When you press TAPE (CD-CH), the power automatically comes on. You do not have to press **⏻/1 ATT** to turn on the power.
- If you change the source, CD changer play also stops. Next time you select the CD changer as the source, CD changer play starts from where playback has been stopped previously.
- When you start playing back a CD Text or an MP3 disc, disc information will automatically appear on the display. (See the explanation that follows.)

To change the display information

While playing back an MP3 file or CD Text, you can change the disc information shown on the display.



Each time you press D (DISP), the display changes to show the following:

For MP3 discs

- When "TAG DISP" is set to "TAG ON" (initial setting: see page 28)

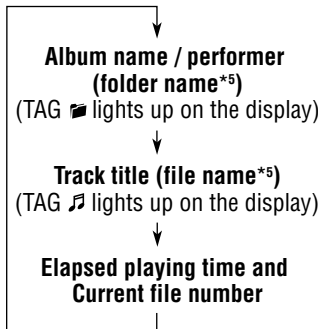

*5 If an MP3 file does not have ID3 tags, folder name and file name appear. In this case, the TAG indicator will not light up on the display.

- When "TAG DISP" is set to "TAG OFF"

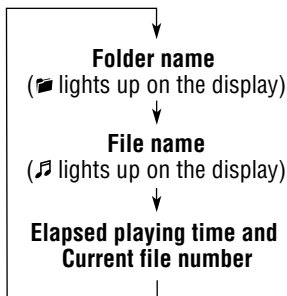

For CD Text discs



Each time you press the button, the display changes as follows:

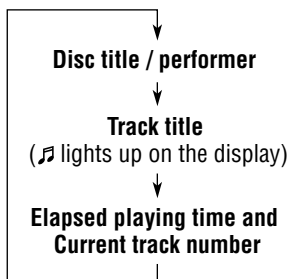

Notes:

- The display shows up to 8 characters at one time and scrolls if there are more than 8 characters. See also "To select the scroll mode—SCROLL" on page 28. Some characters or symbols will not be shown (and be blanked) on the display. (Ex. "ABC&!d#" ⇒ "ABCA D ")
- When you press D (DISP) while playing an audio CD, "NO NAME" appears for the disc title/performer and the track title.

To go to a particular disc directly

Press the number button corresponding to the disc number to start its playback (while the CD changer is playing).

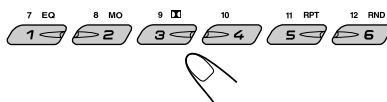

- To select a disc number from 1 – 6: Press 1 (7) – 6 (12) briefly.
- To select a disc number from 7 – 12: Press and hold 1 (7) – 6 (12) for more than one second.

To fast-forward or reverse the track/file

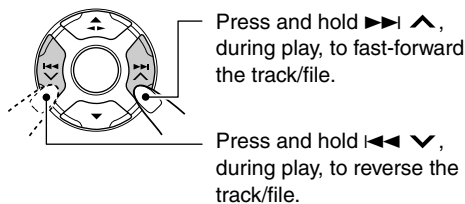

Note:

During this operation on an MP3 disc, you can only hear intermittent sounds. (The elapsed playing time also changes intermittently on the display.)

To go to the next or previous tracks/files

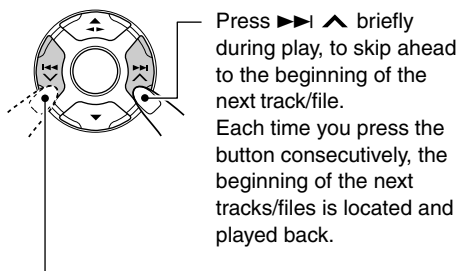

Press **◀◀|▼** briefly during play, to skip back to the beginning of the current track/file. Each time you press the button consecutively, the beginning of the previous tracks/files is located and played back.

This operation is only possible when using JVC MP3-compatible CD changer (CH-X1500).

To go to a track/file quickly

1 Press M (MODE) to enter the functions mode while playing a disc.



"MODE" flashes on the upper part of the display.

2 Press ▲ (up) or ▼ (down) while still in the functions mode.

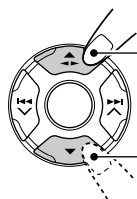

To skip 10 tracks/files* forwards to the last track/file

To skip 10 tracks/files* backwards to the first track/file

* The first time you press ▲ (up) or ▼ (down) button, the track/file skips to the nearest higher or lower track/file with a track/file number of multiple ten (ex. 10th, 20th, 30th). Then each time you press the button, you can skip 10 tracks/files (see "How to go to the desired track/file quickly" on the right column).

- After the last track/file, the first track/file will be selected, and vice versa.

Note:

If the current playing disc is an MP3 disc, files are skipped within the same folder.

How to go to the desired track/file quickly

- Ex. 1: To select track/file number 32 while playing track/file number 6



(Three times)

(Twice)

Track/file 6 → 10 → 20 → 30 → 31 → 32

- Ex. 2: To select track/file number 8 while playing track/file number 36

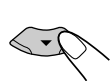

(Three times)

(Twice)

Track/file 36 → 30 → 20 → 10 → 9 → 8

To skip to the next or previous folder (only for MP3 discs)

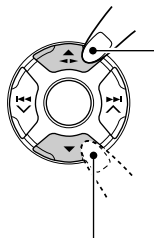

Press ▲ (up) while playing an MP3 disc, to go to the next folder.

Each time you press the button consecutively, the next folder is located, and the first file in the folder starts playback.

Press ▼ (down) while playing an MP3 disc, to go to the previous folder.

Each time you press the button consecutively, the previous folder is located, and the first file in the folder starts playback.

Selecting the playback modes

To play back tracks/files at random (Folder Random/Disc Random/Magazine Random Play)



1 Press M (MODE) to enter the functions mode during play. "MODE" flashes on the upper part of the display.

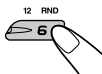

2 Press RND (random), while "MODE" is still flashing on the display. Each time you press the button, the random play mode changes as follows:

For MP3 discs:

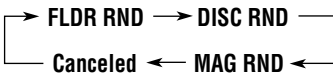

For CDs:

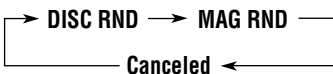



RND indicator

Ex.: When you select "MAG RND"

Note:

The MP3 indicator also lights up if the current playing disc is an MP3 disc.

Mode	Active indicator	Plays at random
FLDR RND*	 and RND indicators light up.	All files of the current folder, then files of the next folder and so on.
DISC RND	 and RND indicators light up.	All tracks/files of the current (or specified) disc.
MAG RND	RND indicator lights up.	All tracks/files of the inserted discs.

* "FLDR RND" is only applicable for MP3 discs.

To play back tracks/files repeatedly (Track Repeat/Folder Repeat/Disc Repeat Play)



1 Press M (MODE) to enter the functions mode during play. "MODE" flashes on the upper part of the display.



2 Press RPT (repeat), while "MODE" is still flashing on the display. Each time you press the button, the repeat play mode changes as follows:

For MP3 discs:

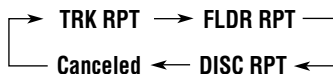

For CDs:

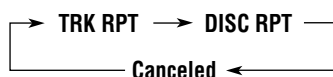



 (disc) and RPT indicators

Ex.: When you select "DISC RPT"

Note:

The MP3 indicator also lights up if the current playing disc is an MP3 disc.

Mode	Active indicator	Plays repeatedly
TRK RPT	RPT indicator lights up.	The current (or specified) track/file.
FLDR RPT*	 and RPT indicators light up.	All files of the current (or specified) folder of the current disc.
DISC RPT	 and RPT indicators light up.	All tracks/files of the current (or specified) disc.

* "FLDR RPT" is only applicable for MP3 discs.

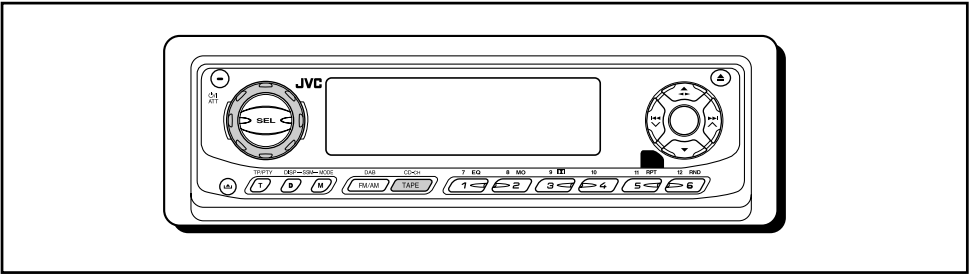

Playing an external component

You can connect the external component to the CD changer jack on the rear using the Line Input Adapter KS-U57 (not supplied).

Preparations:

- For connecting the Line Input Adapter KS-U57 and the external component, refer to the Installation/ Connection Manual (separate volume).
- Before operating the external component using the following procedure, select the external input correctly. See "To select the external component to use—EXT IN" on page 28.

1 Select the external component (LINE IN).



- If "LINE IN"* does not appear on the display, see page 28 and select the external input ("LINE IN").

* Displayed only when one of the following sources is selected—FM, AM, and TAPE.

Note on One-Touch Operation:

When you press TAPE (CD-CH), the power automatically comes on. You do not have to press / I ATT to turn on the power.

2 Turn on the connected component and start playing the source.

3 Adjust the volume.

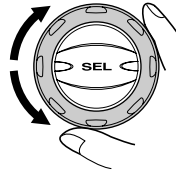

4 Adjust the sound characteristics as you want. (See pages 23 and 24.)

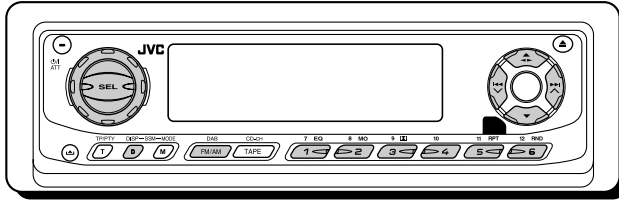

We recommend that you use DAB (Digital Audio Broadcasting) tuner KT-DB1500 or KT-DB1000 with your unit.

If you have another DAB tuner, consult your JVC IN-CAR ENTERTAINMENT dealer.

- Refer also to the Instructions supplied with your DAB tuner.

What is DAB system?

DAB is one of the digital radio broadcasting systems available today. It can deliver CD quality sound without any annoying interference and signal distortion.

Furthermore, it can carry text, pictures, and data.

In contrast to FM broadcast, where each programme is transmitted on its own frequency, DAB combines several programmes (called “services”) to form one “ensemble.”

In addition, each “service”—called “primary service”—can also be divided into its components (called “secondary service”).

With the DAB tuner connected with this unit, you can enjoy these DAB services.

Note:

When reception switches between DAB and FM, the listening volume level may increase or decrease inconveniently. This change in the volume level results from unequal audio injection levels at broadcaster site, but not from the malfunction of this unit.

To prevent this inconvenience, you can adjust the DAB volume level. (See “To adjust the DAB volume level” on page 39.)

Tuning in to an ensemble and one of the services

A typical ensemble has 6 or more programmes (services) broadcast at the same time. After tuning in to an ensemble, you can select a service you want to listen to.

Before you start...

Press FM/AM (DAB) briefly if tape, CD changer, or external component is the current source.

1 Select the DAB tuner.

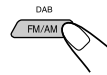

Each time you press and hold the button, the DAB tuner and the FM/AM tuner are alternately selected.

DAB ↔ FM/AM

2 Select the DAB band (DAB1, DAB2, or DAB3).

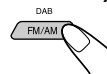

Each time you press the button, the DAB band changes as follows:

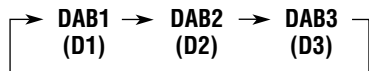

Note:

This receiver has three DAB bands (DAB1, DAB2, DAB3). You can use any of them to tune in to an ensemble.

3 Start searching for an ensemble.

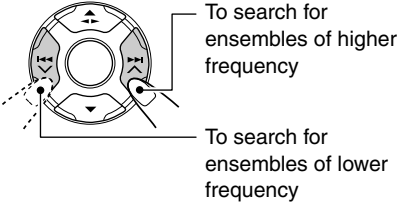

When an ensemble is received, searching stops.

To stop searching before an ensemble is received, press the same button you have pressed for searching.

4 Select a service (either primary or secondary) you want to listen to.

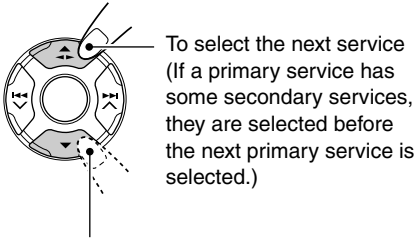

To select the previous service (either primary or secondary)

To change the display information while tuning in to an ensemble

Normally service name is shown on the display. If you want to check the ensemble name or its frequency, press D (DISP).



Each time you press the button, the following information appears for a while in the main display.

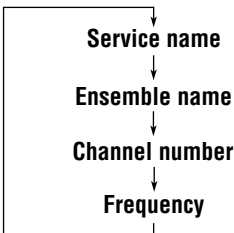

To tune in to a particular ensemble without searching

Before you start...

Press FM/AM (DAB) briefly if tape, CD changer, or external component is the current source.

- 1 Press and hold FM/AM (DAB) to select DAB tuner as the source.
- 2 Press FM/AM (DAB) repeatedly to select the DAB band (DAB1, DAB2, or DAB3).
- 3 Press and hold \blacktriangleright \blacktriangle or \blacktriangleleft \blacktriangledown for more than one second. "MANU" (manual) appears on the display.
- 4 Press \blacktriangleright \blacktriangle or \blacktriangleleft \blacktriangledown repeatedly until the ensemble you want is reached.
 - If you hold down the button, the frequency keeps changing until you release the button.
- 5 Press \blacktriangle (up) or \blacktriangledown (down) to select a service (either primary or secondary) you want to listen to.

To restore the FM/AM tuner

Press and hold FM/AM (DAB) again.

Storing DAB services in memory

You can preset up to 6 DAB services in each DAB band (DAB1, DAB2, and DAB3) manually.

Before you start....

Press FM/AM (DAB) briefly if tape, CD changer, or external component is the current source.

1 Select the DAB tuner.

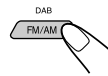

Each time you press and hold the button, the DAB tuner and the FM/AM tuner are alternately selected.

DAB \leftrightarrow FM/AM

2 Select the DAB band (DAB1, DAB2, or DAB3) you want.

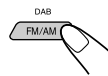

Each time you press the button, the DAB band changes as follows:

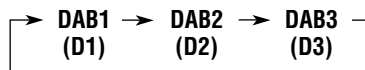

3 Tune in to an ensemble you want.

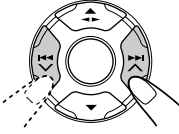

4 Select a service of the ensemble you want to listen to.

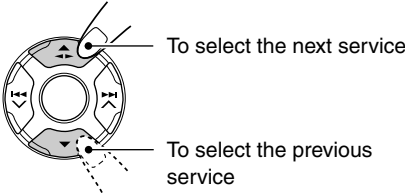

5 Press and hold the number button (in this example, 1) you want to store the selected service into for more than 2 seconds.



Selected band/preset number and "MEMO" (memory) appear alternately for a while.

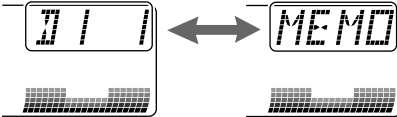

6 Repeat the above procedure to store other DAB services into other preset numbers.

Notes:

- You can only preset primary DAB services. If you store a secondary service, its primary service will be stored instead.
- A previously preset DAB service is erased when a new DAB service is stored in the same preset number.
- Preset DAB services are erased when the power supply to the memory circuit is interrupted (for example, during battery replacement). If this occurs, preset the DAB services again.

Tuning in to a preset DAB service

You can easily tune in to a preset DAB service. Remember that you must store services first. If you have not stored them yet, "Storing DAB services in memory" on pages 37 and 38.

Before you start...

Press FM/AM (DAB) briefly if tape, CD changer, or external component is the current source.

1 Select the DAB tuner.

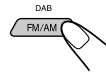

Each time you press and hold the button, the DAB tuner and the FM/AM tuner are alternately selected.

DAB ↔ FM/AM

2 Select the DAB band (DAB1, DAB2, or DAB3) you want.

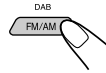

Each time you press the button, the DAB band changes as follows:

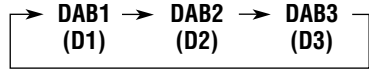

3 Select the number (1 – 6) for the preset DAB service (primary) you want.

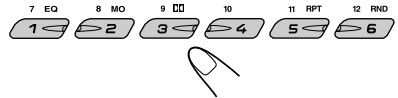

Note:

If the selected primary service has some secondary services, pressing the same number button repeatedly will tune in to the secondary services.

What you can do more with DAB

Tracing the same program automatically (Alternative Reception)

You can keep listening to the same program.

- **While receiving a DAB service:**
When driving in an area where a service cannot be received, this unit automatically tunes in to another ensemble or FM RDS station, broadcasting the same program.
- **While receiving an FM RDS station:**
When driving in an area where a DAB service is broadcasting the same program as the FM RDS station is broadcasting, this unit automatically tunes in to the DAB service.

Note:

When reception switches between DAB and FM, the listening volume level may increase or decrease inconveniently. This change in the volume level results from unequal audio injection levels at broadcaster site, but not from the malfunction of this unit. To prevent this inconvenience, you can adjust the DAB volume level (see the right column).

To use Alternative Reception

When shipped from the factory, Alternative Reception is activated.

- See also “Changing the general settings (PSM)” on page 25.
- 1 Press and hold SEL (select) for more than 2 seconds so that one of the PSM items appears on the display.
 - 2 Press ►►| ^ or |◄◄▼ to select “DAB AF” (alternative frequency).
 - 3 Turn the control dial to select the desired mode.
 - AF ON: Traces the program among DAB services and FM RDS stations —Alternative Reception. The AF indicator lights up on the display (see page 12).
 - AF OFF: Alternative Reception is deactivated.
 - 4 Press SEL (select) to finish the setting.

Note:

When Alternative Reception (for DAB services) is activated, Network-Tracking Reception (for RDS stations: see page 12) is also activated automatically. On the other hand, Network-Tracking Reception cannot be deactivated without deactivating Alternative Reception.

To adjust the DAB volume level

You can adjust the volume level of DAB tuner and store it in memory. By adjusting the volume level properly to match it to the FM sound level, you will not need to adjust the volume level each time you change the source.

When shipped from the factory, DAB volume level is set at “00.”

- See also “Changing the general settings (PSM)” on page 25.
- 1 Press and hold SEL (select) for more than 2 seconds so that one of the PSM items appears on the display.
 - 2 Press ►►| ^ or |◄◄▼ to select “DAB VOL” (DAB volume).
 - 3 Turn the control dial to set to the desired volume.
You can set it from “VOL –12” to “VOL 12.”
 - 4 Press SEL (select) to finish the setting.



TROUBLESHOOTING

What appears to be trouble is not always serious. Check the following points before calling a service center.

	Symptoms	Causes	Remedies
General	<ul style="list-style-type: none"> Sound cannot be heard from the speakers. 	<p>The volume level is set to the minimum level.</p> <p>Connections are incorrect.</p>	<p>Adjust it to the optimum level.</p> <p>Check the cords and connections.</p>
	<ul style="list-style-type: none"> This unit does not work at all. 	<p>The built-in microcomputer may have functioned incorrectly due to noise, etc.</p>	<p>Press the reset button on the panel holder after detaching the control panel. (The clock setting and preset stations stored in memory are erased.) (See page 2.)</p>
FM/AM	<ul style="list-style-type: none"> SSM (Strong-station Sequential Memory) automatic preset does not work. 	<p>Signals are too weak.</p>	<p>Store stations manually.</p>
	<ul style="list-style-type: none"> Static noise while listening to the radio. 	<p>The aerial is not connected firmly.</p>	<p>Connect the aerial firmly.</p>
Tape Playback	<ul style="list-style-type: none"> A cassette tape cannot be ejected. 	<p>Cassette is locked.</p>	<p>Unlock the cassette. (See page 22.)</p>
	<ul style="list-style-type: none"> A cassette tape cannot be inserted. 	<p>You have tried to insert a cassette in the wrong way.</p>	<p>Insert the cassette with the exposed tape facing right.</p>
	<ul style="list-style-type: none"> Cassette tapes become hot. 	<p>This is not a malfunction.</p>	<p>_____</p>
	<ul style="list-style-type: none"> Tape sound is at very low level and sound quality is degraded. 	<p>The tape head is dirty.</p>	<p>Clean it with a head cleaning tape.</p>



Symptoms	Causes	Remedies
<ul style="list-style-type: none"> • “NO DISC” appears on the display. 	No disc is in the magazine.	Insert discs into the magazine.
	Discs are inserted upside down.	Insert discs correctly.
	Discs are unplayable.	Insert playable discs.
<ul style="list-style-type: none"> • “NO MAG” appears on the display. 	No magazine is loaded in the CD changer.	Insert the magazine.
<ul style="list-style-type: none"> • “NO FILES” appears on the display. 	The current disc does not contain any MP3 files.	Insert a disc that contains MP3 files.
<ul style="list-style-type: none"> • MP3 disc is skipped or cannot be played back. 	MP3 files do not have the extension code—mp3 in their file names.	Add the extension code —mp3 to their file names.
	MP3 files are not recorded in the format compliant with ISO 9660 Level 1, Level 2, or Joliet.	Change the disc. (Record MP3 files using a compliant application.)
<ul style="list-style-type: none"> • Noise is generated while playing an MP3 disc. 	The file played back is not an MP3 file (although it has the extension code—mp3).	Skip to another file or change the disc. (Do not add the extension code—mp3 to non-MP3 files.)
<ul style="list-style-type: none"> • A longer readout time is required for an MP3 disc (“CHECK” keeps flashing on the display). 	Readout time varies due to the complexity of the folder/file configuration.	Do not use too many hierarchies and folders. Also, do not record any other types of audio tracks together with MP3 files.
<ul style="list-style-type: none"> • MP3 files cannot be played back as you have intended them to play. 	Playback order is determined when the files are recorded.	_____
<ul style="list-style-type: none"> • Elapsed playing time is not correct for an MP3 disc. 	This sometimes occurs during play. This is caused by how the files are recorded on the disc.	_____
<ul style="list-style-type: none"> • “RESET 8” appears on the display. 	This unit is not connected to the CD changer correctly.	Connect this unit and the CD changer correctly and press the reset button of the CD changer.
<ul style="list-style-type: none"> • “RESET 1” – “RESET 7” appears on the display. 	_____	Press the reset button of the CD changer.
<ul style="list-style-type: none"> • The CD changer does not work at all. 	The built-in microcomputer may have function incorrectly due to noise, etc.	Press the reset button on the panel holder after detaching the control panel. (The clock setting and preset stations stored in memory are erased.) (See page 2.)

CD Changer



MAINTENANCE

This unit requires very little attention, but you will be able to extend the life of the unit if you follow the instructions below.

To clean the head

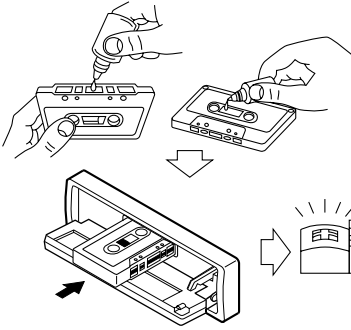

- Clean the heads after every 10 hours of use using a wet-type head cleaning tape (available at an audio store).
When the head becomes dirty, you may realize the following symptoms:
 - Sound quality is reduced.
 - Sound level decreases.
 - Sound drops out.
- Do not play dirty or dusty tapes.
- Do not touch the highly-polished head with any metallic or magnetic tools.

To keep the tape clean

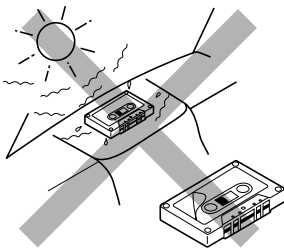

- Always store the cassettes in their storage cases after use.
- Do not store cassettes in the following places:
 - Subject to direct sunlight
 - With high humidity
 - At extremely hot temperatures

CAUTION:

- Do not play the cassettes with peeling labels; otherwise, they can damage the unit.
- Tighten tapes to remove slack since loose tape may become entangled with the mechanism.
- Do not leave a cassette in the cassette compartment after use, as the tape may become slack.

The function below is also provided to ensure the longer life of this unit.

Ignition key-off release/Ignition key-on play

- Turning off the ignition key with a cassette in the compartment automatically releases the tape from the unit's tapehead.
- Turning on the ignition key with a cassette in the compartment starts playback automatically if you turned off the ignition during tape play.

AUDIO AMPLIFIER SECTION

Maximum Power Output:

Front: 50 W per channel

Rear: 50 W per channel

Continuous Power Output (RMS):

Front: 19 W per channel into 4 Ω , 40 Hz to 20 000 Hz at no more than 0.8% total harmonic distortion.

Rear: 19 W per channel into 4 Ω , 40 Hz to 20 000 Hz at no more than 0.8% total harmonic distortion.

Load Impedance: 4 Ω (4 Ω to 8 Ω allowance)

Tone Control Range:

Bass: ± 10 dB at 100 Hz

Treble: ± 10 dB at 10 kHz

Frequency Response: 40 Hz to 20 000 Hz

Signal-to-Noise Ratio: 70 dB

Line-Out Level/Impedance:

2.0 V/20 k Ω load (250 nWb/m)

Output Impedance: 1 k Ω

TUNER SECTION

Frequency Range:

FM: 87.5 MHz to 108.0 MHz

AM: (MW) 522 kHz to 1 620 kHz

(LW) 144 kHz to 279 kHz

[FM Tuner]

Usable Sensitivity:

11.3 dBf (1.0 μ V/75 Ω)

50 dB Quieting Sensitivity:

16.3 dBf (1.8 μ V/75 Ω)

Alternate Channel Selectivity (400 kHz):

65 dB

Frequency Response: 40 Hz to 15 000 Hz

Stereo Separation: 30 dB

Capture Ratio: 1.5 dB

[MW Tuner]

Sensitivity: 20 μ V

Selectivity: 35 dB

[LW Tuner]

Sensitivity: 50 μ V

CASSETTE DECK SECTION

Wow & Flutter: 0.11% (WRMS)

Fast-Wind Time: 100 sec. (C-60)

Frequency Response (Dolby B NR OFF):

30 Hz to 16 000 Hz (Normal tape)

Signal-to-Noise Ratio: 56 dB (Normal tape)

(Dolby B NR ON): 65 dB

(Dolby B NR OFF): 56 dB

Stereo Separation: 40 dB

GENERAL

Power Requirement:

Operating Voltage: DC 14.4 V

(11 V to 16 V allowance)

Grounding System: Negative ground

Allowable Operating Temperature: 0°C to +40°C

Dimensions (W \times H \times D):

Installation Size (approx.):

182 mm \times 52 mm \times 150 mm

Panel Size (approx.):

188 mm \times 58 mm \times 12 mm

Mass (approx.):

1.5 kg (excluding accessories)

Design and specifications are subject to change without notice.

**Having TROUBLE with operation?
Please reset your unit**

Refer to page of How to reset your unit

**Haben Sie PROBLEME mit dem Betrieb?
Bitte setzen Sie Ihr Gerät zurück**

Siehe Seite Zurücksetzen des Geräts

**Vous avez des PROBLÈMES de fonctionnement?
Réinitialisez votre appareil**

Référez-vous à la page intitulée Comment réinitialiser votre appareil

**Hebt u PROBLEMEN met de bediening?
Stel het apparaat terug**

Zie de pagina met de paragraaf Het apparaat terugstellen

JVC

VICTOR COMPANY OF JAPAN, LIMITED



EN, GE, FR, NL

© 2003 VICTOR COMPANY OF JAPAN, LIMITED



0403KKSMdTJEIN

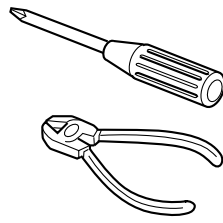

ENGLISH

- This unit is designed to operate on 12 V DC, NEGATIVE ground electrical systems.

INSTALLATION (IN-DASH MOUNTING)

- The following illustration shows a typical installation. However, you should make adjustments corresponding to your specific car. If you have any questions or require information regarding installation kits, consult your JVC IN-CAR ENTERTAINMENT dealer or a company supplying kits.

- Before mounting:** Press (control panel release button) to detach the control panel if already attached.
 - * When shipped from the factory, the control panel is packed in the hard case.
- Remove the trim plate.
- Remove the sleeve after disengaging the sleeve locks.
 - Stand the unit.
 - Note:** When you stand the unit, be careful not to damage the fuse on the rear.
 - Insert the 2 handles between the unit and the sleeve, as illustrated, to disengage the sleeve locks.
 - Remove the sleeve.
 - Note:** Be sure to keep the handles for future use after installing the unit.
- Install the sleeve into the dashboard.
 - * After the sleeve is correctly installed into the dashboard, bend the appropriate tabs to hold the sleeve firmly in place, as illustrated.
- Fix the mounting bolt to the rear of the unit's body and place the rubber cushion over the end of the bolt.
- Do the required electrical connections.
- Slide the unit into the sleeve until it is locked.
- Attach the trim plate.
 - Note:** Ensure the recessed part is at the bottom. If not, the control panel will not open completely.
- Attach the control panel.

DEUTSCH

- Dieses Gerät ist für einen Betrieb in elektrischen Anlagen mit 12 V Gleichstrom und (-) Erdung ausgelegt.

EINBAU (IM ARMATURENBRETT)

- Die folgende Abbildung zeigt einen typischen Einbau. Dennoch müssen Sie entsprechend Ihrem jeweiligen Auto Anpassungen vornehmen. Bei irgendwelchen Fragen oder wenn Sie Informationen hinsichtlich des Einbausatzes brauchen, wenden Sie sich an ihren JVC Autoradiohändler oder ein Unternehmen das diese Einbausätze vertreibt.

- Vor dem Einbau:** Drücken Sie (Freigabe der Schalttafel), um die Arretierung der Schalttafel zu lösen, sofern diese bereits angebracht ist.
 - * Bei der Auslieferung ab Werk ist die Schalttafel im Etui verpackt.
- Den Frontrahmen herausnehmen.
- Die Halterung nach dem Entriegeln der Halterungssperren abnehmen.
 - Das Gerät aufstellen.
 - Hinweis:** Beim Aufstellen des Geräts darauf achten, daß die Sicherung auf der Rückseite nicht beschädigt wird.
 - Die 2 Griffe zwischen dem Gerät und der Halterung wie abgebildet einstecken und die Halterungssperren entriegeln.
 - Die Halterung entfernen.
 - Hinweis:** Sicherstellen, daß die Griffe für künftigen Gebrauch nach dem Einbau des Geräts aufbewahrt werden.
- Die Halterung im Armaturenbrett einbauen.
 - * Nach dem korrekten Einbau der Halterung im Armaturenbrett, die entsprechenden Riegel umknicken, um die Halterung an ihrem Platz zu sichern, siehe Abbildung.
- Die Befestigungsschraube an der Rückseite des Gerätekörpers befestigen und das Ende der Schraube mit einem Gummipuffer abdecken.
- Nehmen Sie die erforderlichen elektrischen Anschlüsse vor.
- Das Gerät in die Halterung schieben, bis es einrastet.
- Befestigen Sie den Frontrahmen.
 - Hinweis:** Vergewissern Sie sich, dass sich die Aussparung an der Unterseite befindet. Ist dies nicht der Fall, lässt sich die Bedienungsblende nicht vollständig öffnen.
- Die Schalttafel anbringen.

FRANÇAIS

- Cet appareil est conçu pour fonctionner sur des sources de courant continu de 12 V à masse NEGATIVE.

INSTALLATION (MONTAGE DANS LE TABLEAU DE BORD)

- L'illustration suivante est un exemple d'installation typique. Cependant, vous devez faire les ajustements correspondant à votre voiture particulière. Si vous avez des questions ou avez besoin d'information sur des kits d'installation, consulter votre revendeur d'autoradios JVC ou une compagnie d'approvisionnement.

- Avant le montage:** Appuyer sur (déblocage du panneau de commande) pour éventuellement détacher le panneau de commande.
 - * Lorsque ce panneau de commande sort d'usine, il est rangé dans un étui de transport.
- Retirer la plaque d'assemblage.
- Libérer les verrous du manchon et retirer le manchon.
 - Poser l'appareil à la verticale.
 - Remarque:** Lorsque vous mettez l'appareil à la verticale, faire attention de ne pas endommager le fusible situé sur l'arrière.
 - Insérer les 2 poignées entre l'appareil et le manchon comme indiqué pour désengager les verrous de manchon.
 - Retirer le manchon.
 - Remarque:** S'assurer de garder les poignées pour une utilisation ultérieure, après l'installation de l'appareil.
- Installer le manchon dans le tableau de bord.
 - * Après installation correcte du manchon dans le tableau de bord, plier les bonnes pattes pour maintenir fermement le manchon en place, comme montré.
- Monter le boulon de montage sur l'arrière du corps de l'appareil puis passer l'amortisseur en caoutchouc sur l'extrémité du boulon.
- Réalisez les connexions électriques.
- Faire glisser l'appareil dans le manchon jusqu'à ce qu'il soit verrouillé.
- Attachez la plaque d'assemblage.
 - Remarque:** Assurez-vous que la partie encastrée est en bas. Sinon, le panneau de commande ne pourra pas être ouvert complètement.
- Remonter le panneau de commande.

NEDERLANDS

- Dit apparaat mag worden gebruikt bij elektrische systemen die werken op 12 V gelijkstroom met negatieve aarding.

INSTALLATIE (INBOUW IN HET DASHBOARD)

- Op de volgende afbeelding kunt u zien hoe de installatie, normaal gesproken, in zijn werk gaat. U moet echter bij de installatie rekening houden met de bijzonderheden van uw eigen auto. Neem bij vragen of voor meer bijzonderheden over inbouwpakketten contact op met uw JVC car audio dealer of een dealer of een bedrijf dat inbouwpakketten levert.

- Voordat u aan de montage van het apparaat begint:** Druk op (het bedieningspaneel vrijgeven) als u het bedieningspaneel wilt loskoppelen indien dit aan de eenheid is vastgekoppeld.
 - * Standaard wordt het bedieningspaneel bij het verlaten van de fabriek los verpakt meegeleverd.
- Verwijder de sierplaat.
- Verwijder het huis nadat u de klemmen hebt losgemaakt.
 - Zet het apparaat rechtop.
 - Opmerking:** Wanneer u het apparaat rechtop zet, moet u erop letten dat u de zekering aan de achterkant niet beschadigt.
 - Plaats de 2 hendels, zoals afgebeeld, tussen het apparaat en het huis, om de klemmen los te maken.
 - Verwijder het huis.
 - Opmerking:** Bewaar de hendels nadat u het apparaat hebt geïnstalleerd, zodat u ze ook in de toekomst kunt gebruiken.
- Installeer het huis in het dashboard.
 - * Nadat het huis op de juiste wijze in het dashboard is geplaatst, moet u de palletjes, zoals afgebeeld, stevig op hun plaats duwen.
- Maak de bevestigingsbout aan de achterkant van het apparaat vast en plaats de rubberdop over het uiteinde van de bout.
- Breng de vereiste elektrische verbindingen tot stand.
- Schuif het apparaat in het huis totdat het vergrendeld is.
- Bevestig een sierplaat.
 - Opmerking:** Zorg dat het ingedeukte gedeelte onder is. Het bedieningspaneel kan anders namelijk niet geheel worden geopend.
- Bevestig het bedieningspaneel.

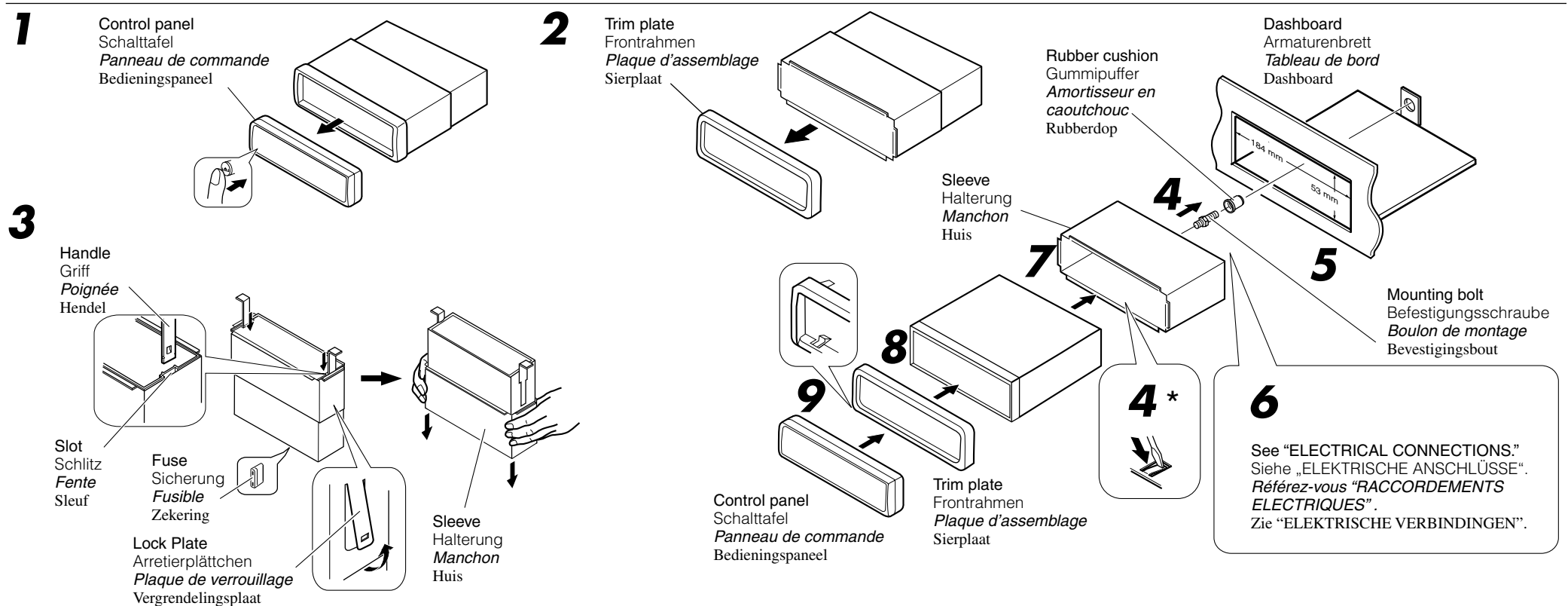

TROUBLESHOOTING

- The fuse blows.**
 - * Are the red and black leads connected correctly?
- Power cannot be turned on.**
 - * Is the yellow lead connected?
- No sound from the speakers.**
 - * Is the speaker output lead short-circuited?
- Sound is distorted.**
 - * Is the speaker output lead grounded?
 - * Are the "-" terminals of L and R speakers grounded in common?
- Unit becomes hot.**
 - * Is the speaker output lead grounded?
 - * Are the "-" terminals of L and R speakers grounded in common?

FEHLERSUCHE

- Die Sicherung brennt durch.**
 - * Sind die roten und schwarzen Leitungen richtig angeschlossen?
- Stromversorgung kann nicht eingeschaltet werden.**
 - * Ist die gelbe Leitung angeschlossen?
- Kein Ton aus den Lautsprechern.**
 - * Ist die LautsprecherAusgangsleitung kurzgeschlossen?
- Ton verzerrt.**
 - * Ist die LautsprecherAusgangsleitung geerdet?
 - * Sind die (-) Anschlußklemmen der linken und rechten Lautsprecher zusammen geerdet?
- Gerät wird heiß.**
 - * Ist die LautsprecherAusgangsleitung geerdet?
 - * Sind die (-) Anschlußklemmen der linken und rechten Lautsprecher zusammen geerdet?

EN CAS DE DIFFICULTES

- Le fusible saute.**
 - * Les fils rouge et noir sont-ils raccordés correctement?
- L'appareil ne peut pas être mise sous tension.**
 - * Le fil jaune est-elle raccordée?
- Pas de son des enceintes.**
 - * Le fil de sortie d'enceinte est-il court-circuité?
- Le son est déformé.**
 - * Le fil de sortie d'enceinte est-il à la masse?
 - * Les bornes "-" des enceintes gauche et droit sont-elles mises ensemble à la masse?
- L'appareil devient chaud.**
 - * Le fil de sortie d'enceinte est-il à la masse?
 - * Les bornes "-" des enceintes gauche et droit sont-elles mises ensemble à la masse?

PROBLEMEN OPLOSSEN

- De zekering slaat door.**
 - * Zijn de rode en de zwarte draden op de juiste manier aangesloten?
- De stroom kan niet worden ingeschakeld.**
 - * Is de gele draad aangesloten?
- Er komt geen geluid uit de speakers.**
 - * Is de uitgaande speakerdraad kortgesloten?
- Het geluid wordt vervormd.**
 - * Is de uitgaande speakerdraad geaard?
 - * Zijn de "-" polen van de linker- en de rechterspeakers gemeenschappelijk geaard?
- Het apparaat raakt verhit.**
 - * Is de uitgaande speakerdraad geaard?
 - * Zijn de "-" polen van de linker- en de rechterspeakers gemeenschappelijk geaard?

- When using the optional stay
- Beim Verwenden der Anker-Option
- Lors de l'utilisation du hauban en option
- Wanneer u de steun gebruikt (facultatief)

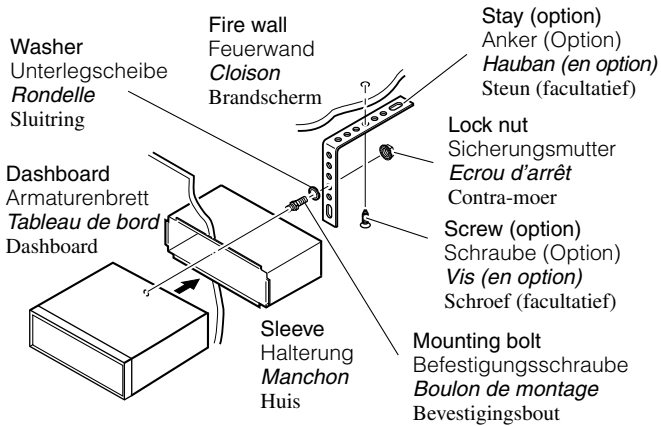

- When installing the unit without using the sleeve
- Beim Einbau des Geräts ohne Halterung
- Lors de l'installation de l'appareil sans utiliser de manchon
- Wanneer u het apparaat zonder huis installeert

In a Toyota for example, first remove the car radio and install the unit in its place.
Zum Beispiel in einem Toyota zuerst das Autoradio ausbauen und dann das Gerät an seinem Platz einbauen.
Par exemple dans une Toyota, retirer d'abord l'autoradio et installer l'appareil à la place.
Voorbeeld: Bij een Toyota moet u eerst de autoradio verwijderen en daarna het apparaat installeren.

- Flat type screws (M5 x 6 mm)*
- Senkkopfschrauben (M5 x 6 mm)*
- Vis à tête plate (M5 x 6 mm)*
- Platkopfschroeven (M5 x 6 mm)*

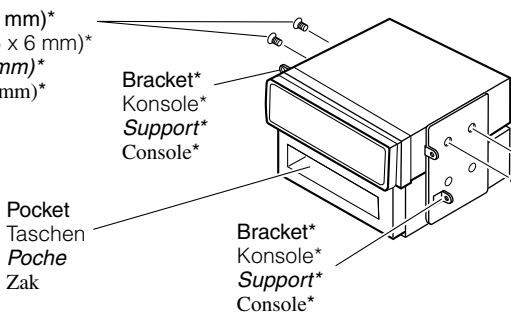

- * Not included with this unit.
- * Nicht Teil dieses Geräts.
- * Non fourni avec cet appareil.
- * Niet meegeleverd.

- Flat type screws (M5 x 6 mm)*
- Senkkopfschrauben (M5 x 6 mm)*
- Vis à tête plate (M5 x 6 mm)*
- Platkopfschroeven (M5 x 6 mm)*

- Note** : When installing the unit on the mounting bracket, make sure to use the 6 mm-long screws. If longer screws are used, they could damage the unit.
Hinweis : Beim Anbringen des Gerät an der Konsole sicherstellen, daß 6 mm lange Schrauben verwendet werden. Werden längere Schrauben verwendet, können sie das Gerät beschädigen.
Remarque : Lors de l'installation de l'appareil sur le support de montage, s'assurer d'utiliser des vis d'une longueur de 6 mm. Si des vis plus longues sont utilisées, elles peuvent endommager l'appareil.
Opmerking : Wanneer u het apparaat aan de bevestigingsklem vastmaakt, moet u de 6 mm lange schroeven gebruiken. Als u langere schroeven gebruikt, kan het apparaat worden beschadigd.

Less than 30°
Weniger als 30°
Moins de 30°
Kleiner dan 30°

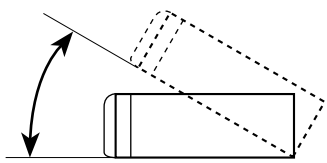

Install the unit at an angle of less than 30°.
Stellen Sie das Gerät mit einem Winkel von weniger als 30° auf.
Installez l'appareil avec un angle de moins de 30°.
Installeer het toestel met een hoek kleiner dan 30°.

Removing the unit

- Before removing the unit, release the rear section.
- 1 Remove the control panel.
- 2 Remove the trim plate.
- 3 Insert the 2 handles into the slots, as shown. Then, while gently pulling the handles away from each other, slide out the unit. (Be sure to keep the handles after installing it.)

Ausbau des Geräts

- Vor dem Ausbau des Geräts den hinteren Teil freigegeben.
- 1 Den Schalttafel abnehmen.
- 2 Den Frontrahmen herausnehmen.
- 3 Die 2 Griffe in die Schlitz wie gezeigt stecken. Dann die Griffe behutsam auseinander ziehen und das Gerät herausziehen. (Die Griffe nach dem Einbau auf jeden Fall aufbewahren.)

Retrait de l'appareil

- Avant de retirer l'appareil, libérer la section arrière.
- 1 Retirer le panneau de commande.
- 2 Retirer la plaque d'assemblage.
- 3 Introduire les 2 poignées dans les fentes, comme montré. Puis, tout en tirant doucement les poignées écartées, faire glisser l'appareil pour le sortir. (S'assurer de conserver les poignées après l'installation de l'appareil.)

Verwijderen van het apparaat

- Voordat u het apparaat verwijdert, moet u het achtergedeelte losmaken.
- 1 Verwijder het bedieningspaneel.
- 2 Verwijder de sierplaat.
- 3 Plaats de 2 hendels, zoals afgebeeld, in de sleuven. Daarna duwt u de hendels zachtjes uit elkaar en kunt u het apparaat naar buiten schuiven. (Bewaar de hendels nadat u het apparaat hebt geïnstalleerd!)

1

Control panel
Schalttafel
Panneau de commande
Bedieningspaneel

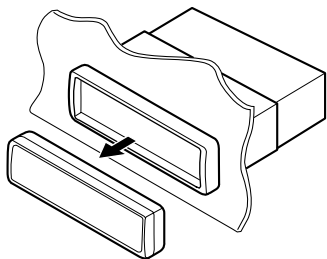

2

Trim plate
Frontrahmen
Plaque d'assemblage
Sierplaat

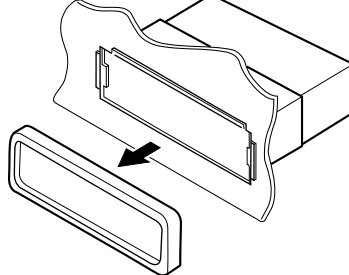

3

Handle
Griff
Poignée
Hendel

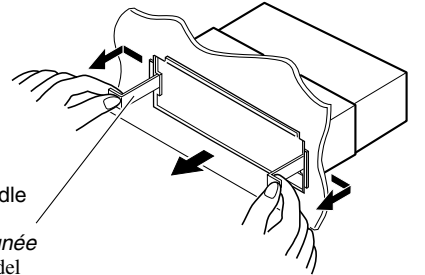

Parts list for installation and connection

The following parts are provided with this unit. After checking them, please set them correctly.

Teilleiste für den Einbau und Anschluß

Die folgenden Teile werden zusammen mit diesem Gerät geliefert. Nach ihrer Überprüfung, die Teile richtig einsetzen.

Liste des pièces pour l'installation et raccordement

Les pièces suivantes sont fournies avec cet appareil. Après vérification, veuillez les placer correctement.

Lijst van onderdelen die u bij installatie en aansluiting nodig hebt

De volgende onderdelen worden bij het apparaat geleverd. Installeer ze op de juiste wijze, nadat u ze hebt gecontroleerd.

Hard case/Control panel
Etui/Schalttafel
Etui de transport/Panneau de commande
Behuizing/Bedieningspaneel

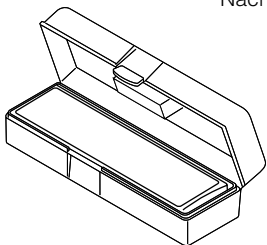

Sleeve
Halterung
Manchon
Huis

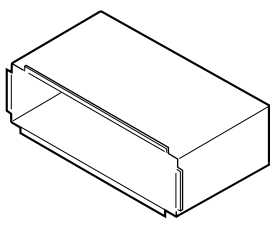

Trim plate
Frontrahmen
Plaque d'assemblage
Sierplaat

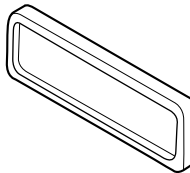

Power cord
Stromkabel
Cordon d'alimentation
Stroomkabel

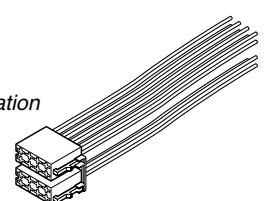

Handles
Griffe
Poignées
Hendels

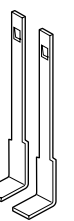

Washer (ø5)
Unterlegscheibe (ø5)
Rondelle (ø5)
Sluitring (ø5)



Lock nut (M5)
Sicherungsmutter (M5)
Ecrou d'arrêt (M5)
Contra-moer (M5)



Mounting bolt (M5 x 20 mm)
Befestigungsschraube (M5 x 20 mm)
Boulon de montage (M5 x 20 mm)
Bevestigingsbout (M5 x 20 mm)



Rubber cushion
Gummipuffer
Amortisseur en caoutchouc
Rubberdop



Battery
Batterie
Pile
Batterij



Remote controller
Fernbedienung
Télécommande
Afstandsbediening



ELECTRICAL CONNECTIONS

To prevent short circuits, we recommend that you disconnect the battery's negative terminal and make all electrical connections before installing the unit. If you are not sure how to install this unit correctly, have it installed by a qualified technician.

Note:

This unit is designed to operate on 12 V DC, **NEGATIVE ground electrical systems**. If your vehicle does not have this system, a voltage inverter is required, which can be purchased at JVC IN-CAR ENTERTAINMENT dealers.

- Replace the fuse with one of the specified rating. If the fuse blows frequently, consult your JVC IN-CAR ENTERTAINMENT dealer.
- If noise is a problem... This unit incorporates a noise filter in the power circuit. However, with some vehicles, clicking or other unwanted noise may occur. If this happens, connect the unit's **rear ground terminal** (see connection diagram) to the car's chassis using shorter and thicker cords, such as copper braiding or gauge wire. If noise still persists, consult your JVC IN-CAR ENTERTAINMENT dealer.
- Maximum input of the speakers should be more than 50 W at the rear and 50 W at the front, with an impedance of **4 Ω to 8 Ω**.
- **Be sure to ground this unit to the car's chassis.**
- The heat sink becomes very hot after use. Be careful not to touch it when removing this unit.

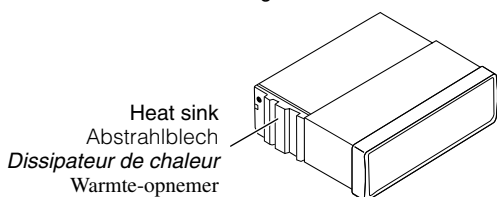

ELEKTRISCHE ANSCHLÜSSE

Zur Vermeidung von Kurzschlüssen empfehlen wir, daß Sie den negativen Batterieanschluß abtrennen und alle elektrischen Anschlüsse herstellen, bevor das Gerät eingebaut wird. Sind Sie sich über den richtigen Einbau des Geräts nicht sicher, lassen Sie es von einem qualifizierten Techniker einbauen.

Hinweis:

Dieses Gerät ist für einen Betrieb in **elektrischen Anlagen mit 12 V Gleichstrom und (-) Erdung ausgelegt**. Verfügt Ihr Fahrzeug nicht über diese Anlage, ist ein Spannungsinverter erforderlich, der bei JVC Autoradiohändler erworben werden kann.

- Die Sicherung mit einer der entsprechenden Nennleistung ersetzen. Brennt die Sicherung häufig durch, wenden Sie sich an Ihren JVC Autoradiohändler.
- Sind Störgeräusche ein Problem... Dieses Gerät enthält ein Störfilter im Stromkreis. Bei manchen Fahrzeugen kann jedoch ein Klicken oder andere unerwünschte Störgeräusche auftreten. Sollte das der Fall sein, die **hintere Erdungsanschlußklemme** (siehe Schaltplan) des Geräts am Fahrwerk des Fahrzeugs anschließen, dabei kürzere und dickere Kabel wie beispielsweise Kupfergeflechtdraht oder Stahldraht verwenden. Bleibt Störgeräusch bestehen, wenden Sie sich an Ihren JVC Autoradiohändler.
- Die maximale Eingangsleistung der Lautsprecher sollte mehr als 50 W hinten und 50 W vorn bei einer Impedanz von **4 Ω bis 8 Ω** betragen.
- **Sicherstellen, daß das Gerät am Fahrwerk geerdet wird.**
- Das Abstrahlblech wird nach dem Gebrauch sehr heiß. Beim Ausbau des Geräts darauf achten, das Abstrahlblech nicht zu berühren.

RACCORDEMENTS ELECTRIQUES

Pour éviter tout court-circuit, nous vous recommandons de débrancher la borne négative de la batterie et d'effectuer tous les raccordements électriques avant d'installer l'appareil. Si l'on n'est pas sûr de pouvoir installer correctement cet appareil, le faire installer par un technicien qualifié.

Remarque:

Cet appareil est conçu pour fonctionner sur des sources de courant continu de 12 V à masse **NEGATIVE**. Si votre véhicule n'offre pas ce type d'alimentation, il vous faut un convertisseur de tension, que vous pouvez acheter chez un revendeur d'autoradios JVC.

- Remplacer le fusible par un de la valeur précisée. Si le fusible saute souvent, consulter votre revendeur d'autoradios JVC.
- Si le bruit est un problème... Cet appareil incorpore un filtre de bruit dans le circuit d'alimentation. Cependant, avec certains véhicules, quelques claquements ou autres bruits non désirés risquent de se produire. Si cela arrive, raccorder la borne arrière de masse de l'appareil au châssis de la voiture (voir le diagramme de raccordement) en utilisant des cordons les plus gros et les plus courts possibles telle qu'une barre de cuivre ou une tresse. Si le bruit persiste, consulter votre revendeur d'autoradios JVC.
- La puissance admissible des enceintes devrait supérieure à 50 W à l'arrière et à 50 W l'avant, avec une impédance de 4 Ω à 8 Ω.
- S'assurer de raccorder la mise à la masse de cet appareil au châssis de la voiture.
- Le dissipateur de chaleur devient très chaud après usage. Faire attention de ne pas le toucher en retirant cet appareil.

ELEKTRISCHE VERBINDINGEN

Om kortsluiting te voorkomen adviseren wij u om de minpool van de accu los te maken en alle elektrische verbindingen tot stand te brengen voordat u het apparaat in de auto installeert. Als u niet zeker weet hoe u dit apparaat moet installeren, kunt u dit beter door een daartoe gekwalificeerde technicus laten doen.

Opmerking:

- Dit apparaat mag worden gebruikt bij elektrische systemen die werken op 12 V gelijkstroom met negatieve aarding. Als uw auto niet is uitgerust met een dergelijk systeem, is een spanningsomzetter vereist. Dit instrument kan worden aangeschaft bij JVC car audio dealers.
- Vervang de zekering door een exemplaar met het aangegeven vermogen. Als de zekering vaak doorslaat, moet u uw JVC car audio dealer raadplegen.
- Als u geluidsproblemen hebt... De krachtschakeling van dit apparaat heeft een ingebouwd geluidsfilter. In sommige voertuigen zijn tikgeluiden of andere ongewenste geluiden te horen. Als dit gebeurt, moet u de **massaklem aan de achterkant** (zie aansluitingsschema) aan het chassis van de auto vastmaken met behulp van een kortere en dikkere kabel, zoals kopermanteldraad of tellerkabel. Als het geluid niet verdwijnt, moet u contact opnemen met uw JVC car audio dealer.
- Het maximum ingangsvermogen van de speakers moet achterin meer dan 50 W zijn en voorin 50 W, met een impedantie van 4 Ω tot 8 Ω.
- **Zorg ervoor dat dit apparaat door middel van een aardkabel is verbonden met het chassis van de auto.**
- De warmte-opnemer kan na gebruik erg heet worden. Raak de warmte-opnemer niet aan wanneer u dit apparaat van zijn plaats haalt.

Typical Connections / Typische Anschlüsse / Raccordements typiques / Normale verbindingen

Before connecting: Check the wiring in the vehicle carefully. Incorrect connection may cause serious damage to this unit.

The leads of the power cord and those of the connector from the car body may be different in color.

1 Connect the colored leads of the power cord to the car battery, speakers and power aerial (if any) in the following sequence.

- ① Black: ground
- ② Yellow: to car battery (constant 12 V)
- ③ Red: to an accessory terminal
- ④ Blue with white stripe: to remote lead of other equipment or power aerial if any (200 mA max.)
- ⑤ Orange with white stripe: to car light control switch
- ⑥ Brown: to cellular phone system (For details, refer to the instructions of the cellular phone.)
- ⑦ Others: to speakers

2 Connect the aerial cord.

3 Finally connect the wiring harness to the unit.

Note: If your vehicle does not have any accessory terminal, move the fuse from the fuse position 1 (initial position) to fuse position 2, and connect the red lead (A7) to the positive (+) battery terminal.

- The yellow lead (A4) is not used in this case.

Vor dem Anschließen: Die Verdrahtung im Fahrzeug sorgfältig überprüfen. Falsche Anschlüsse können ernsthafte Schäden am Gerät hervorrufen. Die Leiter des Stromkabels und die Leiter des Anschlusses im Fahrzeug können sich farblich unterscheiden.

1 Die farbigen Leitungen des Spannungsversorgungskabels an der Autobatterie, entstekingsschakelaarden Lautsprechern und dem Motorantenne (sofern vorhanden) in folgender Reihenfolge anschließen.

- ① Schwarz: Erdung
- ② Gelb: an Autobatterie (konstant 12 V)
- ③ Rot: zur einer Zubehörschlußklemme
- ④ Blau mit weißem Streifen: zum Zusatzkabel des anderen Geräts oder der Motorantenne, sofern vorhanden (max. 200 mA)
- ⑤ Orange mit weißem Streifen: zum Autolichtschalter
- ⑥ Braun: an Mobiltelefon (Weitere Informationen entnehmen Sie bitte der Bedienungsanleitung des Mobiltelefons.)
- ⑦ Andere: zur Lautsprecher

2 Das Antennenkabel anschließen.

3 Die Kabelbäume am Gerät anschließen.

Hinweis: Verfügt Ihr Fahrzeug nicht über eine Zubehörschlußklemme, die Sicherung von der 1. Sicherungsposition (Erstposition) in die 2. Sicherungsposition versetzen, die rote Leitung (A7) an der (+) Batterieanschlußklemme anschließen.

- Die gelbe Leitung (A4) wird in diesem Fall nicht verwendet.

Avant de commencer la connexion: Vérifiez attentivement le câblage du véhicule. Une connexion incorrecte peut endommager sérieusement l'appareil. Le fil du cordon d'alimentation et ceux des connecteurs du châssis de la voiture peuvent être différents en couleur.

1 Connectez les fils de couleur du cordon d'alimentation à la batterie de la voiture, aux enceintes et à l'antenne automatique (s'il y en a une) dans l'ordre suivant.

- ① Noir: à la masse
- ② Jaune: à la batterie de la voiture (12 V constant)
- ③ Rouge: à une borne accessoire
- ④ Bleu avec bande blanche: au fil de télécommande de l'autre appareil ou à l'antenne automatique s'il y en a une (200 mA max.)
- ⑤ Orange avec bande blanche: à l'interrupteur d'éclairage de la voiture
- ⑥ Marron: à un système de téléphone cellulaire (Pour les détails, se référer aux instructions du téléphone cellulaire.)
- ⑦ Autres: aux enceintes

2 Connectez le cordon d'antenne.

3 Finalement, connectez le faisceau de fils à l'appareil.

Remarque: Si votre véhicule ne possède pas de borne accessoire, déplacez le fusible de la position de fusible 1 (position originale) à la position de fusible 2 et connectez le fil rouge (A7) à la borne positive (+) de la batterie.

- Le fil jaune (A4) n'est pas utilisé dans ce cas.

Alvorens te verbinden: Controleer de bedrading in de auto zorgvuldig. Het apparaat kan door verkeerde verbinding ernstige schade oplopen. De draden van het stroomkabel verschillen mogelijk van kleur met de aansluitingen op het chassis van de auto.

1 Sluit de gekleurde snoerdraden van de stroomkabel in de hierna genoemde volgorde aan op de accu van de auto, de luidsprekers en de antenne (indien aanwezig).

- ① Zwart: aarde
- ② Geel: naar de accu van de auto (constant 12 V)
- ③ Rood: naar de aansluitklem van de accessoire
- ④ Blauw met witte streep: naar afstandsbedieningsdraad van andere apparatuur of antenne met circuit indien aanwezig (200 mA max.)
- ⑤ Oranje met witte streep: naar de schakelaar voor de autoverlichting
- ⑥ Bruin: naar het mobiele-telefoonstelsel (Lees voor meer informatie de instructies die bij de mobiele telefoon worden geleverd.)
- ⑦ Andere: naar de speakers

2 Sluit de antenne aan.

3 Verbind de draadbundel daarna met het apparaat.

Opmerking: Als uw voertuig niet beschikt over een aansluitklem, moet u de zekering verplaatsen van stand 1 (beginstand) naar stand 2 en moet u de rode draad (A7) met de pluspool (+) van de accu verbinden.

- In dit geval wordt de gele draad (A4) niet gebruikt.

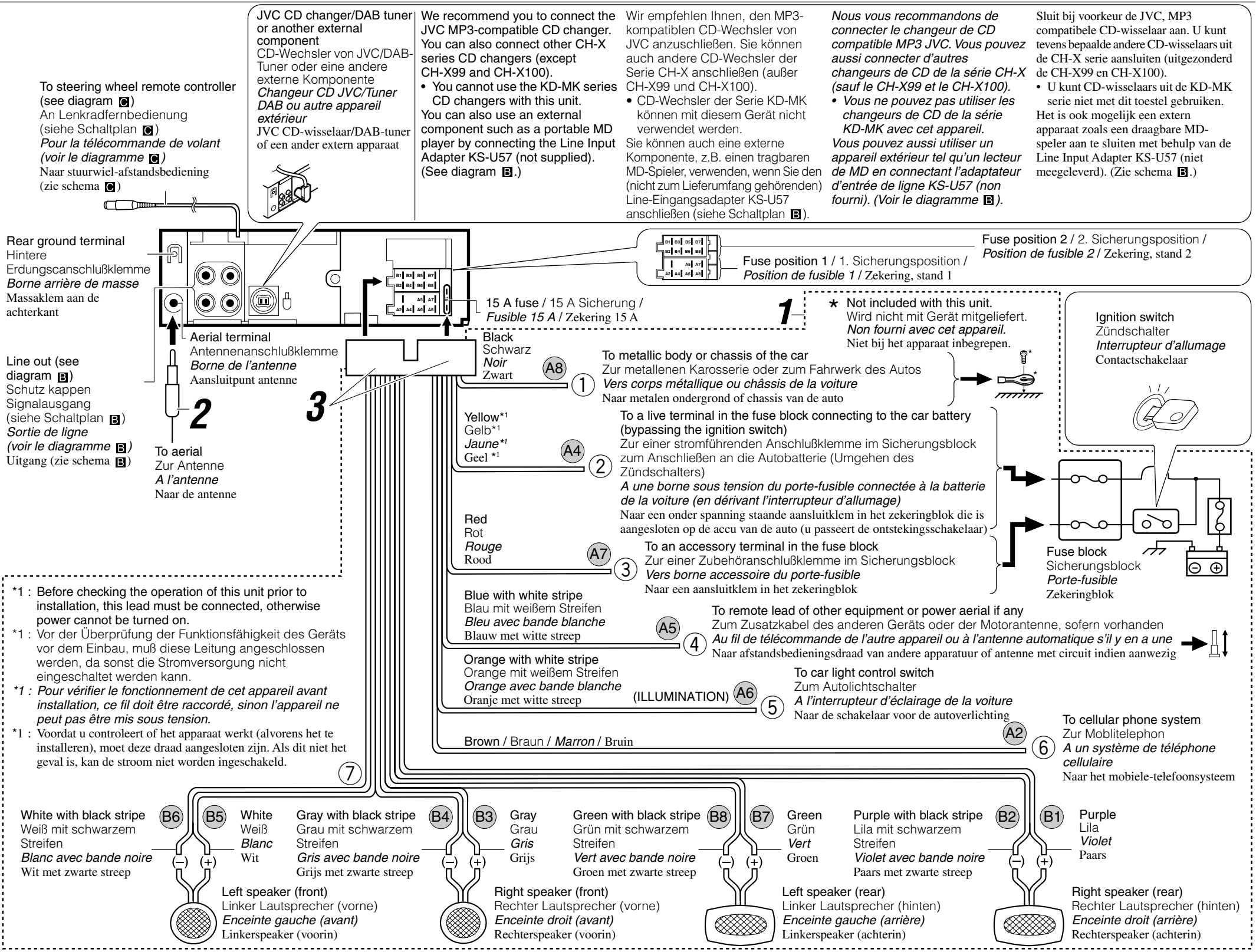

PRECAUTIONS on power supply and speaker connections:

- DO NOT connect the speaker leads of the power cord to the car battery; otherwise, the unit will be seriously damaged.
- Connect the black lead (ground), yellow lead (to car battery, constant 12 V), and red lead (to an accessory terminal) correctly.
- BEFORE connecting the speaker leads of the power cord to the speakers, check the speaker wiring in your car.
- If the speaker wiring in your car is as illustrated in Fig. 1 and Fig. 2 below, DO NOT connect the unit using that original speaker wiring. If you do, the unit will be seriously damaged. Redo the speaker wiring so that you can connect the unit to the speakers as illustrated in Fig. 3.
- If the speaker wiring in your car is as illustrated in Fig. 3, you can connect the unit using the original speaker wiring in your car.
- If you are not sure of the speaker wiring of your car, consult your car dealer.

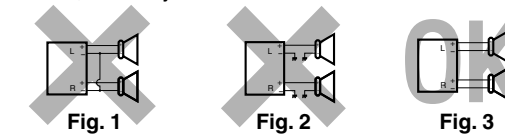

VORSICHTSMASSREGELN beim Anschließen der Stromversorgung und Lautsprecher:

- Die Lautsprecherleitungen des Netzkabels NICHT an der Autobatterie anschließen, da sonst das Gerät schwer beschädigt wird.
- Die schwarze Leitung (Erdung), die gelbe Leitung (zur Autobatterie, konstant 12 V) und die rote Leitung (zur Zubehörschlußklemme) richtig anschließen.
- VOR dem Anschließen der Lautsprecherleitungen des Spannungsversorgungskabels an die Lautsprecher, die Lautsprecherverdrahtung in Ihrem Auto überprüfen.
- Ist die Lautsprecherverdrahtung wie unten in „Fig. 1“ und „Fig. 2“ abgebildet, das Gerät NICHT mit der Originalverdrahtung der Lautsprecher anschließen, da sonst das Gerät schwer beschädigt wird. Die Lautsprecherverdrahtung erneuern, so daß Sie das Gerät an den Lautsprechern wie in „Fig. 3“ abgebildet anschließen können.
- Ist die Lautsprecherverdrahtung in Ihrem Auto wie in „Fig. 3“ abgebildet, können Sie das Gerät mit der Originalverdrahtung der Lautsprecher in Ihrem Auto anschließen.
- Sind Sie sich über die Lautsprecherverdrahtung in Ihrem Auto nicht sicher, wenden Sie sich an Ihren Autohändler.

PRECAUTIONS sur l'alimentation et la connexion des enceintes:

- NE CONNECTEZ PAS les fils d'enceintes du cordon d'alimentation à la batterie; sinon, l'appareil serait sérieusement endommagé.
- Connectez correctement le fil noir (à la masse), le fil jaune (à la batterie de la voiture, 12 V constant) et le fil rouge (à la prise accessoire).
- AVANT de connecter les fils d'enceintes du cordon d'alimentation aux enceintes, vérifiez le câblage des enceintes de votre voiture.
- Si le câblage des enceintes de votre voiture est comme montré sur la Fig. 1 ou Fig. 2 ci-dessous, NE CONNECTEZ PAS l'appareil en utilisant ce câblage original des enceintes. Si vous le faites, l'appareil sera sérieusement endommagé. Recommencez le câblage des enceintes de façon que vous puissiez connecter l'appareil aux enceintes comme montré sur la Fig. 3.
- Si le câblage des enceintes de votre voiture est comme montré sur la Fig. 3, vous pouvez connecter l'appareil en utilisant ce câblage original d'enceintes pour votre voiture.
- Si vous n'êtes pas sûrs du câblage d'enceintes de votre voiture, consulter le concessionnaire de votre voiture.

VOORZORGSMAATREGELEN bij het verbinden van de stroomkabeldraad met de speakers:

- Verbind de speakerdraden van de stroomkabel NIET met de accu van de auto; als u dit wel doet, zal het apparaat ernstige schade oplopen.
- Sluit de zwarte draad (aarde), de gele draad (naar de accu van de auto, constant 12 V) en de rode draad (naar de aansluitklem van de accessoire) op de juiste wijze aan.
- VOORDAT u de speakerdraden van de stroomkabel met de speakers verbindt, moet u de bedrading van de speakers in uw auto controleren.
- Als de bedrading van de speakers eruitziet zoals hieronder staat afgebeeld in Fig. 1 en Fig. 2, mag het apparaat NIET worden aangesloten met behulp van deze oorspronkelijke speakerbedrading. Als u dat wel doet, zal het apparaat ernstige schade oplopen. Pas de bedrading van de speakers aan, zodat u het apparaat met de speakers kunt verbinden, zoals staat afgebeeld in Fig. 3.
- Als de bedrading van de speakers eruitziet zoals staat afgebeeld in Fig. 3, kunt u het apparaat aansluiten met behulp van de oorspronkelijke speakerbedrading in uw auto.
- Als u twijfels hebt over de speakerbedrading in uw auto, moet u contact opnemen met uw autodealer.

Connecting the leads / Anschließen der Leitungen / Raccordement des fils / Aansluiting van de gekleurde draden

Twist the core wires when connecting.
Die Kerndrähte beim Anschließen verdrehen.
Torsader les âmes des fils en les raccordant.
Draai de kerndraden om elkaar heen wanneer u ze wilt aansluiten.

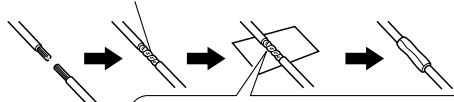

Solder the core wires to connect them securely.
Die Kerndrähte anlöten, um sie fest anzuschließen.
Souder les âmes des fils pour les raccorder entre eux de façon sûre.
Soldeer de kerndraden zodat ze stevig vast zitten.

CAUTION / VORSICHT / PRECAUTION / LET OP!:

- To prevent short-circuit, cover the terminals of the UNUSED leads with insulating tape.
- Zur Vermeidung eines Kurzschlusses die Anschlußklemmen der NICHT VERWENDETEN Leitungen mit Isolierklebeband umwickeln.
- Pour éviter les court-circuits, couvrir les bornes des fils qui ne sont PAS UTILISÉS avec de la bande isolante.*
- Om kortsluiting te voorkomen, moet u de aansluitklemmen van ONGEBRUIKTE gekleurde draden met isolatieband bedekken.

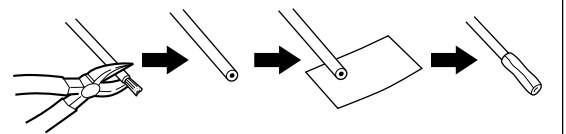

Connections Adding Other Equipment / Anschlüsse zum Hinzufügen von anderer Ausrüstung / Raccordement pour ajouter d'autres appareils / Aansluitingen voor het toevoegen van andere apparatuur

You can connect an amplifier and other equipment to upgrade your car stereo system.

- Connect the remote lead (blue with white stripe) to the remote lead of the other equipment so that it can be controlled through this unit.
- For amplifier only:
 - Connect this unit's line-out terminals to the amplifier's line-in terminals.
 - Disconnect the speakers from this unit, connect them to the amplifier. Leave the speaker leads of this unit unused. (Cover the terminals of these unused leads with insulating tape, as illustrated above.)**

Sie können einen Verstärker oder ein anderes Gerät anschließen, um Ihre Autostereoanlage zu erweitern.

- Schließen Sie das Fernbedienungskabel (blau mit weißem Streifen) an das Fernbedienungskabel des anderen Geräts an, so daß es über dieses Gerät gesteuert werden kann.
- Nur für den Verstärker:
 - Die Anschlußklemmen am Ausgang dieses Gerät an den Anschlußklemmen des Eingangs des Verstärkers anschließen.
 - Die Lautsprecher von diesem Gerät abtrennen und am Verstärker anschließen. Die Lautsprecherleitungen dieses Geräts unbenutzt lassen. (Die Anschlußklemmen dieser nicht verwendeten Leitungen mit Isolierklebeband umwickeln, siehe Abbildung oben.)**

Vous pouvez connecter un amplificateur ou autre appareil pour améliorer votre système autoradio.

- Connectez le fil de commande à distance (bleu avec bande blanche) au fil de commande à distance de l'autre appareil de façon qu'il puisse être commandé via cet appareil.*
- Pour l'amplificateur seulement:*
 - Raccorder les bornes de sortie ligne de cet appareil aux bornes d'entrée ligne de l'amplificateur.*
 - Déconnectez les enceintes de cet appareil et connectez-les à l'amplificateur. Laissez les fils d'enceintes de cet appareil inutilisés. (Recouvrir les extrémités de ces fils inutilisés avec de la bande isolante comme montré ci-dessus.)*

Het is mogelijk om uw autostereosysteem uit te breiden met een versterker of andere apparatuur.

- Verbind de afstandsbedieningsdraad (blauw met witte streep) met de afstandsbedieningsdraad van andere apparatuur zodat deze op afstand via dit apparaat kan worden bediend.
- Alleen voor een versterker:
 - Verbind de uitgang van het apparaat met de ingang van de versterker.
 - Koppel de speakers van dit apparaat los en verbind ze aan de versterker. Gebruik de speakerdraden van dit apparaat niet. (Plak de aansluitklemmen van deze speakerdraden met isolatieband af zoals hierboven is afgebeeld.)**

Amplifier / Verstärker / Amplificateur / Versterker

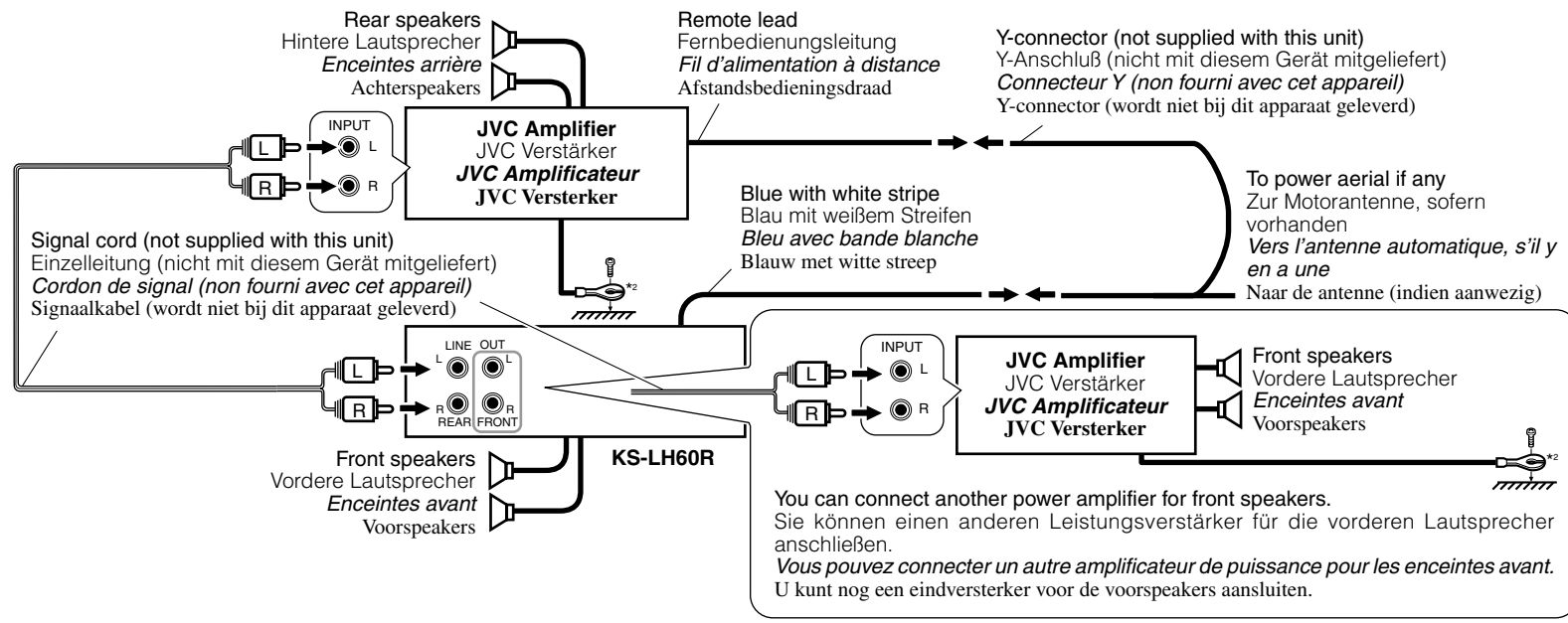

*2 : Firmly attach the ground wire to the metallic body or to the chassis of the car—to the place not coated with paint (if coated with paint, remove the paint before attaching the wire). Failure to do so may cause damage to the unit.

*2 : Verbinden Sie den Erdungsleiter mit der Karosserie oder dem Rahmen des Fahrzeugs. Die Kontaktstelle darf nicht lackiert sein (sollte die Kontaktstelle lackiert sein, entfernen Sie den Lack der Kontaktstelle, bevor Sie den Leiter befestigen). Wenn der Erdungsleiter nicht ordnungsgemäß angeschlossen wird, kann dieses Gerät beschädigt werden.

*2 : Attachez solidement le fil de mise à la masse au châssis métallique de la voiture—à un endroit qui n'est pas recouvert de peinture (s'il est recouvert de peinture, enlevez d'abord la peinture avant d'attacher le fil). L'appareil peut être endommagé si cela n'est pas fait correctement.

*2 : Bevestig de aarddraad goed met een metalen onderdeel of het chassis van de auto—bevestig op een niet-gelakt gedeelte (indien gelakt, schuur dan af alvorens de draad te bevestigen). Het toestel kan worden beschadigd indien de aarddraad niet goed is aangesloten.

CD changer and DAB tuner / CD-Wechsler und DAB-Tuner / Changeur CD et tuner DAB / CD-wisselaar en DAB-tuner

You can connect a JVC CD changer and/or a JVC DAB (Digital Audio Broadcasting) tuner.

- For their connections, refer to the Instructions supplied with them.

Sie können einen CD-Wechsler und/oder einen DAB-Tuner (Tuner für digitalen Rundfunk) von JVC anschließen.

- Weitere Informationen über den Anschluß können Sie der Bedienungsanleitung entnehmen, die dem jeweiligen Gerät beiliegt.

Vous pouvez connecter un changeur CD JVC et/ou un tuner DAB (Digital Audio Broadcasting) JVC.

- Pour leurs connexions, référez-vous aux "Manuel d'instructions" qui les accompagnent.*

Het is mogelijk een JVC CD-wisselaar en/of JVC DAB-tuner (Digital Audio Broadcasting) aan te sluiten.

- Zie de Gebruiksaanwijzing van deze apparaten voor meer informatie over het tot stand brengen van deze aansluiting.

Connecting cord supplied with your DAB tuner
Verbindingskabel, dat zum Lieferumfang des DAB-Tuners gehört
Cordon de connexion fourni avec votre tuner DAB
Verbindingskabel die met de DAB-tuner wordt meegeleverd

Connecting cord supplied with your CD changer
Verbindingskabel, dat zum Lieferumfang des CD-Wechsler gehört
Cordon de connexion fourni avec votre changeur CD
Verbindingskabel die met de CD-wisselaar wordt meegeleverd

Connecting cord supplied with your DAB tuner or CD changer
Verbindingskabel, dat zum Lieferumfang des DAB-Tuners oder CD-Wechslers gehört
Cordon de connexion fourni avec votre tuner DAB ou changeur CD
Verbindingskabel die met de DAB-tuner of CD-wisselaar wordt meegeleverd

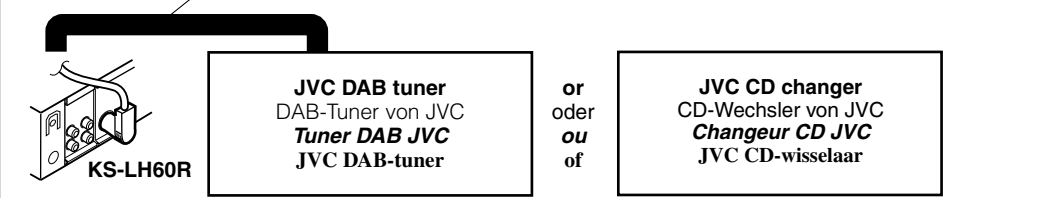
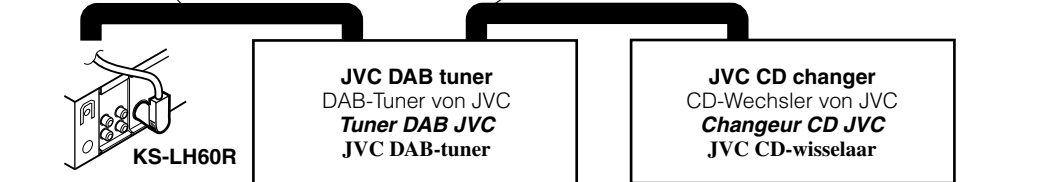

- You can connect both components in series as illustrated above.
- Es ist möglich, beide Komponenten in einer Serienschaltung entsprechend der obigen Darstellung anzuschließen.
- Vous pouvez connecter les deux appareils en série comme montré ci-dessus.*
- Beide apparaten zijn volgens bovenstaande illustratie in serie aan te sluiten.

CAUTION / VORSICHT / PRECAUTION / LET OP!:

- Before connecting the CD changer and/or the DAB tuner, make sure that the unit is turned off.
- Bevor Sie den CD-Wechsler und/oder den DAB-Tuner anschließen, vergewissern Sie sich, daß das Gerät ausgeschaltet ist.
- Avant de connecter le changeur CD et/ou le tuner DAB, s'assurer que l'unité est éteinte.*
- Zorg ervoor dat de apparaat is uitgeschakeld alvorens u de en/of DAB-tuner CD-wisselaar aansluit.

External Component / Externe Komponente / Appareil extérieur / Extern apparaat

Line Input Adapter KS-U57 (not supplied with this unit)
Line-Eingangsadapter KS-U57 (nicht mit diesem Gerät mitgeliefert)
Adaptateur d'entrée de ligne KS-U57 (non fourni avec cet appareil)
Line Input Adapter KS-U57 (wordt niet bij dit apparaat geleverd)

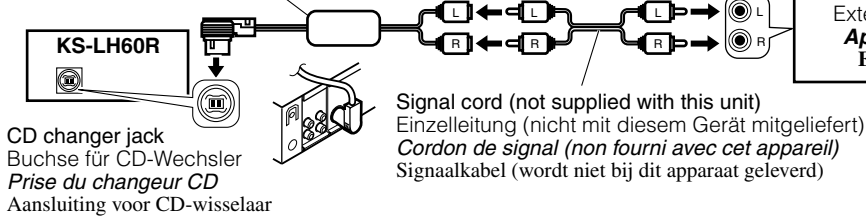

External component
Externe Komponente
Appareil extérieur
Extern apparaat

See the INSTRUCTIONS (separate volume) for how to use the external component with this unit.
Informationen zur Verwendung der externen Komponente mit diesem Gerät finden Sie in den BEDIENUNGSANLEITUNG (separates Dokument).
Référez-vous aux "MANUEL D'INSTRUCTIONS" (manuel séparé) pour savoir comment utiliser l'appareil extérieur avec cet appareil.
Zie de GEBRUIKSAANWIJZING (apart boekje) voor details aangaande het gebruik van het externe component met dit toestel.

Connecting to the steering wheel remote controller / Anschluß an die Lenkradfernbedienung / Connexion de la télécommande de volant / Verbinden met de stuurwiel-afstandsbediening

If your car is equipped with the steering wheel remote controller, you can operate this receiver using the controller. To do it, a JVC's OE remote adapter (not supplied) which matches with your car is required. Consult your JVC IN-CAR ENTERTAINMENT dealer for details.

Wenn Ihr Fahrzeug mit einer Lenkradfernbedienung ausgestattet ist, können Sie damit diesen Receiver steuern. Hierfür ist ein für Ihr Fahrzeug passender Radio-Lenkrad-Fernbedienungsadapter von JVC (nicht im Lieferumfang enthalten) erforderlich. Für weitere Einzelheiten wenden Sie sich an Ihren JVC Autoradiohändler.
Si votre voiture est munie d'une télécommande de volant, vous pouvez commander cet autoradio en utilisant la télécommande. Pour le faire, un adaptateur pour télécommande au volant (non fourni) correspondant à votre voiture est nécessaire. Consultez votre revendeur d'autoradio JVC pour les détails.
Indien uw auto een stuurwiel-afstandsbediening heeft, kunt u deze receiver met die afstandsbediening bedienen. Hiervoor heeft u echter een JVC adapter voor stuurwiel-afstandsbediening (niet bijgeleverd) nodig die geschikt is voor uw auto. Raadpleeg uw JVC car audio dealer voor details.

